

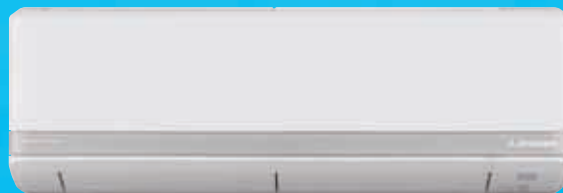

# Eco-lution

High Performance Air-Conditioning



**SR** series

Residential Air Conditioners

50Hz  
10R01E-A-0



# SRK ZJX

Wall Mounted type



**3D AUTO**

Programmed air distribution

**Sophisticated design**

**Quiet operation**

# Eco·lution

Industry leading energy efficiency  
and high reliability  
from our high technology.



# High Efficiency

## Consideration for the Environment

Several radical changes of the design and engineering developments have brought about a vast improvement in energy efficiency and environmental protection.

### ENERGY LABEL "Class A"

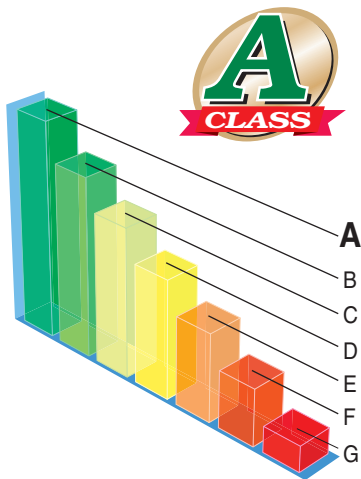

Energy		Air-conditioner	
Manufacturer Outside unit Inside unit			
More efficient			
A			
B			
C			
D			
E			
F			
Less efficient			
G			
Annual energy consumption, kWh in cooling mode <small>(Annual consumption will depend on how the appliance is used and climate)</small>			
Cooling output		kW	
Energy efficiency ratio		Full load (the higher the better)	
Type	Cooling only	—	
	Cooling + Heating	—	
	Air cooled	—	
	Water cooled	—	
Heat output		kW	
Heating performance		A: higher G: lower	
Noise (dB(A) @ 1 pW)			
Further information is contained in product brochures.			
Air-conditioner Energy Label Directive 2002/31/EC			

### Employment of lead-free solder

#### Adapted to RoHS directive

RoHS: Restriction of Hazardous substances

In order to avoid the release of hazardous substances to the global environment, all models have realized applications of lead-free solder.

It has been considered to be difficult to use lead-free solder for practical applications because it requires higher solder temperatures at assembly, which could jeopardize reliability. PbF soldering method developed by us, however, has enabled to realize a higher reliability of quality for lead-free printed circuit boards.

### Employment of R410A

All models use refrigerant R410A characterized by the ozone depletion coefficient being 0.

### Excellent Energy Saving

A High Performance and Excellent Energy Saving are achieved at the same time by an increased capacity of heat exchanger and employment of high efficiency DC motor etc.

## The industry's highest COP levels

All the ZJX and ZE series have cleared the Class A standard, the highest energy saving level, with our high COP.

### EER in Cooling

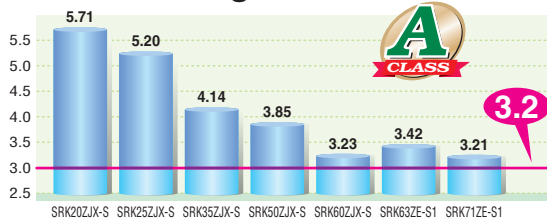

### COP in Heating

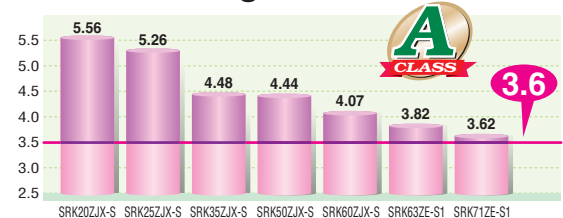

Applied models  
All inverter models

### QUICK & HIGH EFFICIENCY Control

## DC PAM inverter

An inverter driven system has a number of performance advantages over a constant speed system. For example, its variable compressor outputs can ensure quick heating after a startup and attain a set temperature more quickly.

Then, the air conditioner can slow down its compressor speed to save energy, keeping comfortable conditions. Moreover, the compressor is DC driven, so it provides higher performance.



### DC compressor motor

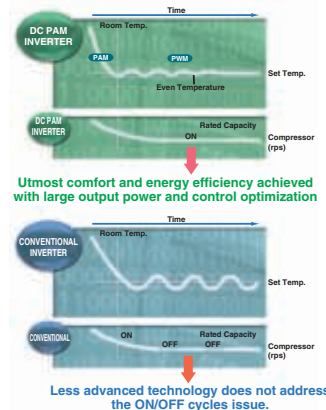
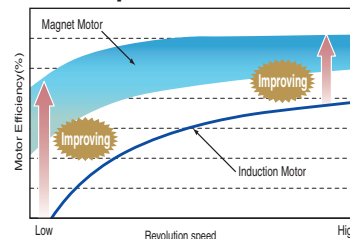

Applied models  
All inverter models  
(except SRK-ZE)

## New Inverter Control (Vector control)

New Inverter Control has applied new advanced technology of Vector control and has realized high efficiency.

- Smooth operation from low speed to high speed
- Smooth Sine Voltage Wave form are attained
- Energy efficiency is further improved in low speed range

## Our latest technologies

### New propeller fan

Matching a new propeller fan with a fan motor has been optimized in order to keep the same capacity as that of previous models with less electrical consumption. Synergy effect with leaf shape grill has realized improvement of energy efficiency by 5% and decrease of sound level. (SRC40/50/60ZIX-S)



Serration fan

### Silicon-coated PCB

The printed wiring board of the outdoor unit is coated by silicon. It lasts long having a tolerance for humidity.



### Energy saving leaf shape grill

Radial shape grill has been developed in order to realize natural air flow sent by propeller fan along with it. Airflow is very smooth with minimum air resistance and it can make decrease motor load and lead to improvement of energy efficiency.

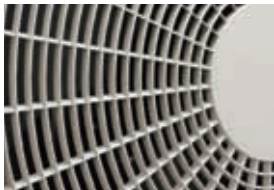

### High efficiency scroll compressor Realizing low vibration and low sound level

Thanks to applying scroll compressor, improvement of energy efficiency has been realized with lower vibration and lower sound level. Furthermore high efficiency and high output has realized by use of neodymium magnet applied in the motor. The magnet produces huge neodymium energy, reducing loss occurred during compression of refrigeration. (SRC40/50/60ZIX-S)



photo is composite image

### Superior corrosion resistance hot dipping steel sheet

Superior corrosion resistance hot dipping steel sheet is applied at base of outdoor units. It has superior corrosion resistance and scratch resistance properties compared to conventional materials.



### Indoor unit

Optimization of combination of fin configuration and copper tube has achieved maximum air flow keeping size in width of indoor unit. Efficiency rate of heat exchanger has been drastically improved by 33% compared with previous models. New fin can realize maximum air flow and saving energy simultaneously. (except SRK-ZJP)

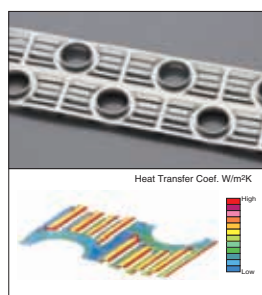

### Outdoor unit

Thanks to changing fin configuration from flat sheet to new M shape fin, efficiency has been improved by 10%. Optimum balance of heat transfer and air flow has been achieved in a high-dimensional structure.

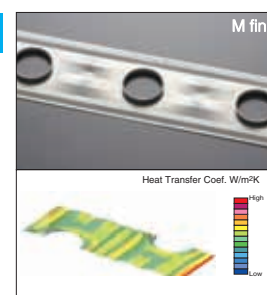

## 3D AUTO Vertical + Horizontal AIR SCROLL

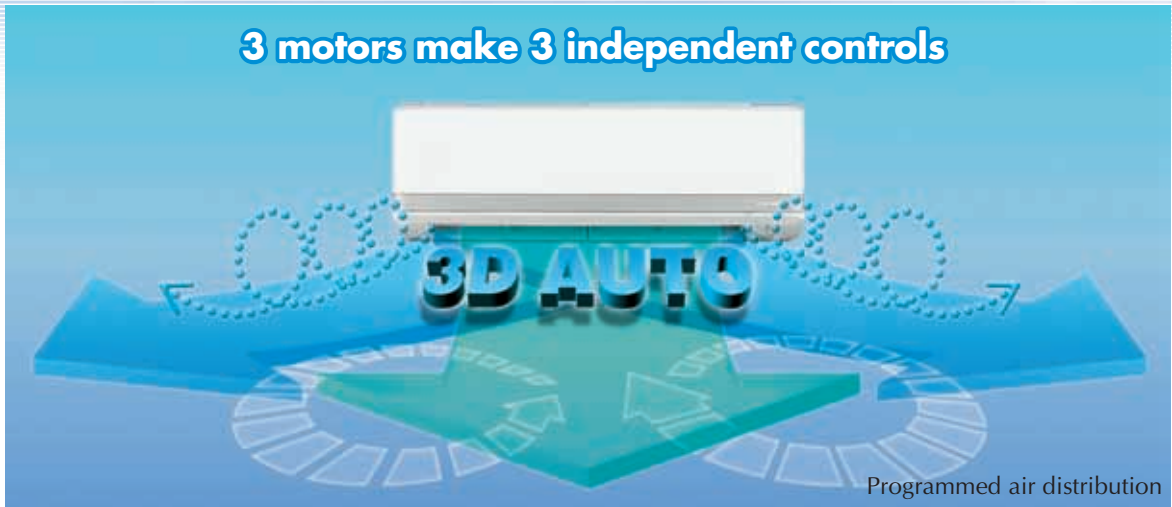

Applied models  
SRK-ZJX, SRK-ZJR,  
SRK-ZJ  
SRK63/71ZE, HE :  
Manual Setting only

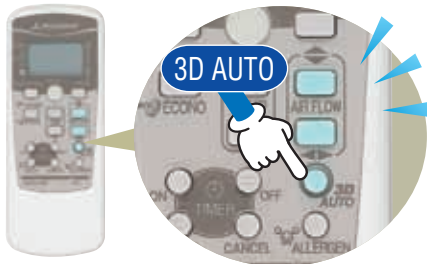

3D AUTO is one touch programmed and three motors (one vertical working motor + two horizontal working motors) make three independent air flow controls. The airflow is uniform and quiet and reaches at long distance points from the blower.

### Programmed 3D AUTO

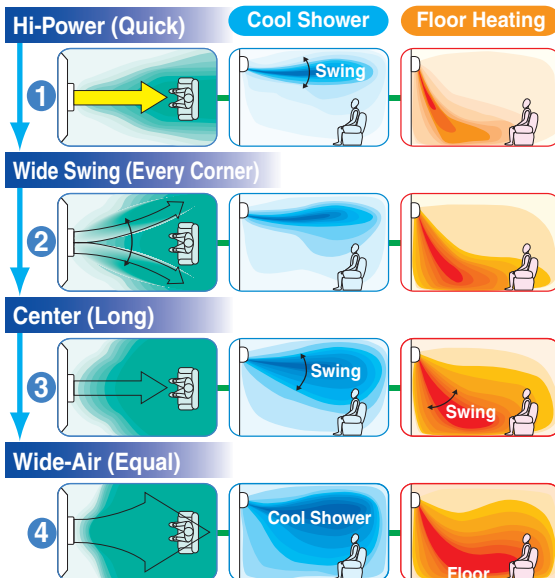

Thanks to automatic control of air flow volume and air flow direction, comfortable air conditioning of the entire room can be done effectively.  
In cooling operation cooled air flows directly to the ceiling. The cooled air does not flow directly to the occupants of the room and the comfort cooled air flow comes from the ceiling like a soft shower.  
In heating operation warm air flows to the floor directly and spreads along the floor. Due to concentration of the warm air on the floor level, optimum comfort can be realized.

### Manual Setting

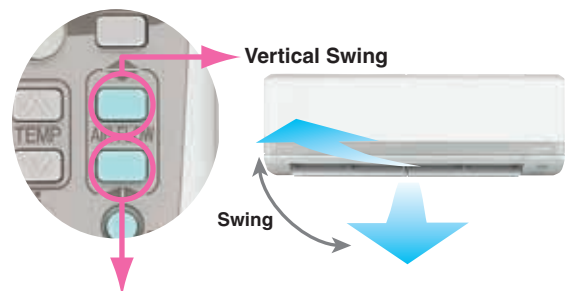

### Horizontal Air Scroll 8 Direction Swing

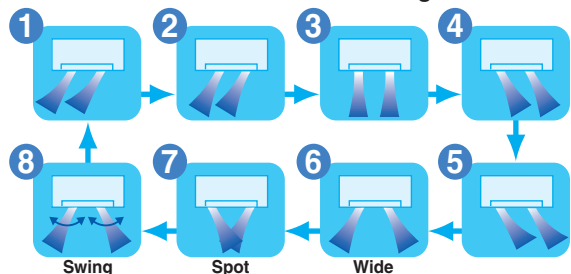

By individual control of right and left part of louver, air flow direction from the right part and the left part are controlled individually. Setting the most preferable air flow direction and determining whether direct air flow is required or not at the same time minimizing of energy loss and economical operation has realized.

**Aircraft technology was used in the design of the air conditioner's airflow system**

## Jet Air Scroll Long Reach & Silent Air Flow

Applied models  
All SRK

**We used the same aerodynamic analysis technology as used in developing jet engines.**

CFD (computational fluid dynamics), used in blade shape design of jet engines, has been applied to the design of air channels in air conditioners to develop the ideal air channel system (air circulation). The airflow of the jets created in this system enable a large volume of air to be blown with minimum power consumption, yet the air flow is uniform, quiet and reaches points a long distance from the blower.

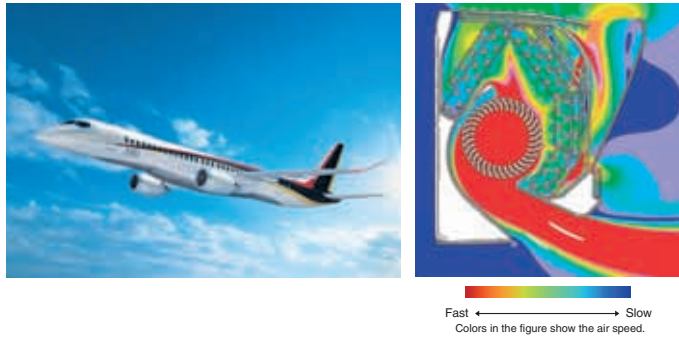

### Long Reach Air Flow

Powerful airflow is realized by Jet technology. Good for large living rooms and shops. Increase your comfort.



Applied models  
SRK50/60ZJX,  
SRK63/71ZE, HE

### Positioning of Installation

You can set the left-right air flow directions when you installed the air conditioner near the side wall by remote controller operation.

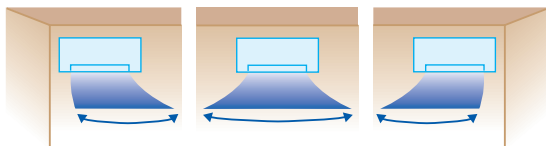

Applied models  
SRK-ZJX, SRK-ZJR,  
SRK-ZJ

### New louver

Due to redesigned size and shape, the new louver has been increased in surface area by 80%. In addition to increase of air flow volume, it has improved controllability of swinging to right and left.

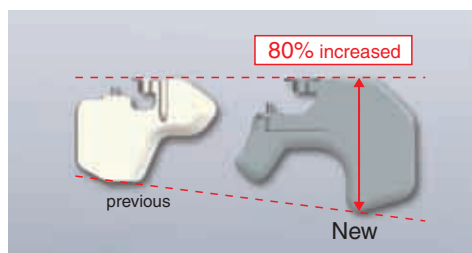

Applied models  
SRK-ZJX

# Clean Air



Applied models  
SRK-ZJX, SRK-ZE,  
SRK-HG, SRK-HE



**Generates the same amount of negative ions as a forest environment**

## 24-hour ION

The air conditioner main body employs a tourmaline-coated sheet. The sheet generates negative ions around the clock. Even when the air conditioner is not running, it generates as many negative ions (2,500– 3,000/cc) as in a forest, stream or fall does, allowing you to experience them without incurring any electrical charges.

Applied models  
SRK-ZJX, SRK-ZE,  
SRK-ZJR, SRK-ZJ,  
SRK-ZJP, SRK-HG,  
SRF-ZJX, SRR-ZJ

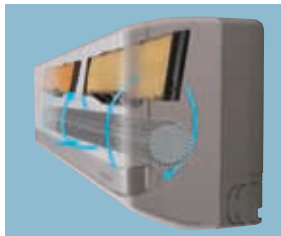

**Always keeping the indoor unit clean**

## Self Clean Operation

“Self clean operation” is operated for 2 hours after the unit has stopped its normal operation.

The indoor unit is dried up and the growth of mold is restrained. Users can select whether this mode is utilized or not.

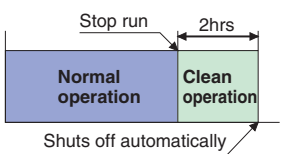

### Situation of mold after one week

When you don't execute “Self Clean Operation”



When you execute “Self Clean Operation”

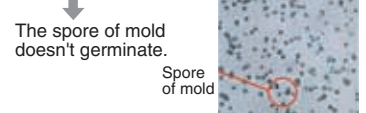

Applied models  
SRK-ZJX, SRK-ZE,  
SRK-ZJR, SRK-ZJ

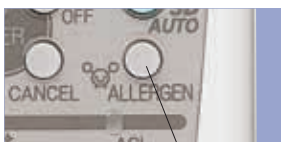

Push ALLERGEN Mode

**The air in your room is kept fresh**

## Allergen Clear System

**First in the world**

“Allergen clear system” is equipped to suppress the influence of the allergen caught by the filter by controlling the temperature and humidity.

20 of Patent Pending

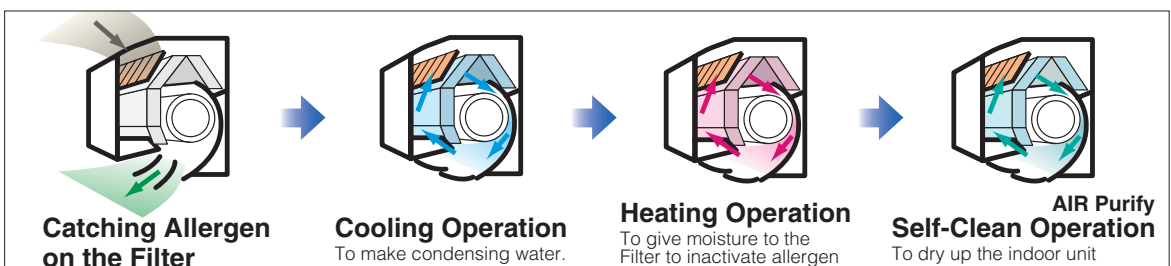

**This is the original and only technology to control the temperature and humidity for inactivating allergens**

## Allergen Clear Filter

**Enzyme + Urea deactivates allergens and kills bacteria.**



The allergen clear filter breaks down the pollen, lice, and allergens that live on cat skins, etc. and deactivates them. The secret of deactivation is the Enzyme-urea compound. It deactivates not only allergens but also all kinds of bacteria, molds and viruses. Even if allergens and bacteria, etc. fly off of the filter, they are deactivated, so the air in your room is kept fresh.

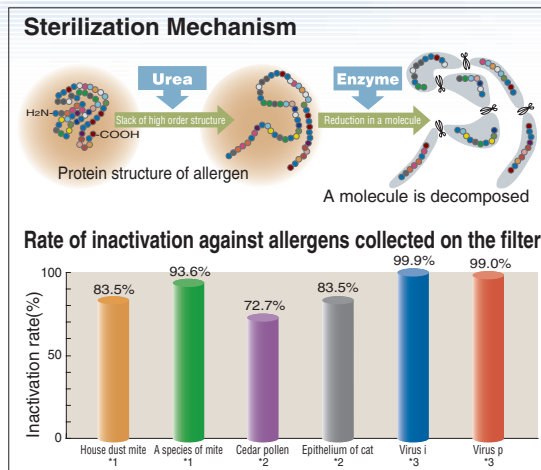

\*1 Test method: ELISA colorimetric method / ELISA fluorescent method  
 Laboratory: Independent administrative agency national hospital mechanism Sagami Hospital, No. 1536  
 \*2 Test method: ELISA colorimetric method  
 Laboratory: Independent administrative agency national hospital mechanism Sagami Hospital, No. 1536  
 \*3 Test method: TCID (Infection value 50%)  
 Laboratory: Foundation of Kitazato Environmental Science Center, No.15-0145

**Sure to destroy fungi and bacteria, also effective on viruses and allergenic compounds (Cat hair, dust mite, pollen etc.)**

## Natural Enzyme Filter

**The first release in this range of the enzyme-sterilizing filter**



Enzymes used in these filters are naturally occurring lytic enzymes. The lytic enzymes attack cell walls of microorganisms trapped on a filter and destroy them and doing so, have a powerful sterilizing which will effect decrease the number of molds and bacteria. Natural Enzyme Filter will clean and sanitize air passing through it to keep air in the room clean and safe.

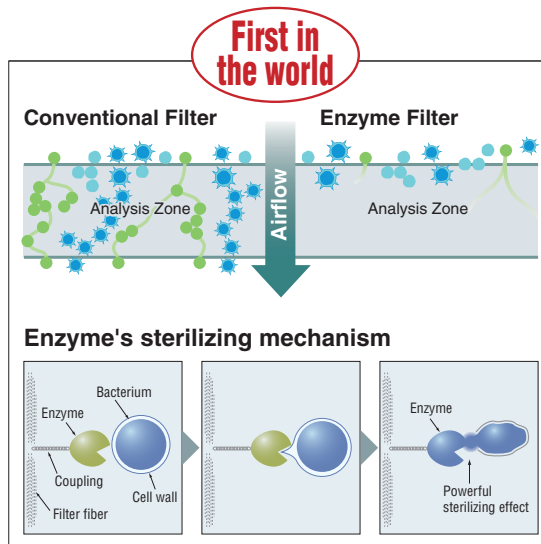

**The deodorizing ability of this filter can be easily restored simply by cleaning and exposing to the sunlight**

## Photocatalytic Washable Deodorizing Filter

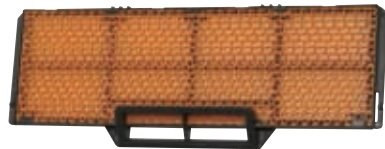

It will keep the air fresh by deodorizing the molecules causing odor. Its deodorizing power can be restored by washing with water and drying under the sun, as such it is a Recycling deodorizing filter capable of repeat use.

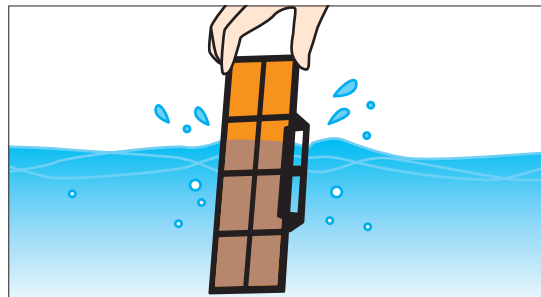

### Used in models

Filter	Indoor Unit	SRK-ZJX	SRK-ZE	SRK-ZJR	SRK-ZJ	SRK-ZJP	SRF-ZJX	SRK-HG	SRK-HE
Allergen Clear Filter		1pc	1pc	1pc	1pc	—	—	—	—
Natural Enzyme Filter		—	—	—	—	—	1pc	1pc	1pc
Photocatalytic Washable Deodorizing Filter		1pc	1pc	1pc	1pc	—	1pc	1pc	1pc

**Anti-microbial specifications and design will deliver cleanliness and safety**

## Anti-microbial blower fan

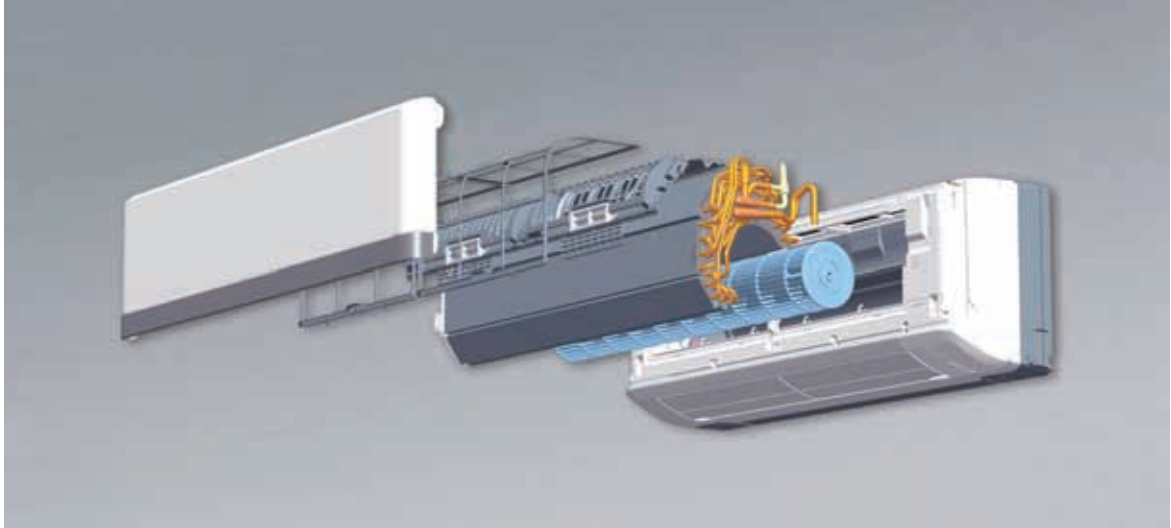

The blower fan has undergone anti-microbial treatment to resist mold and germs, making the system clean and safe. Foul odors and molds, etc. which can occur when an air conditioning system is not in operation are prevented.



Comparison of growth of bacteria and mold on fan surfaces (microscopic image)

- Intestinal bacteria (Escherichia coli IFO 3972)
- Staphylococcus aureus subsp. aureus IFO 12732  
Testing Authority: Japan Food Analysis Center  
Test Results Issued: 2004-4-7.  
Test Report No.: 104034022-001  
Tests were conducted with reference to the antimicrobial strength tests in JIS Z 2801 2000 "Antimicrobial Products-Antimicrobial Test Method" -5.2 Antimicrobial Effects: Test Methods for Plastic Products, etc.
- Aspergillus niger IFO 6341  
Testing Authority: Japan Food Analysis Center  
Test Results Issued: 2004-4-23.  
Test Report No.: 104034022-002  
Tests were conducted with reference to the antimicrobial strength tests in JIS Z 2801 2000 "Antimicrobial Products-Antimicrobial Test Method" -5.2 Antimicrobial Effects: Test Methods for Plastic Products, etc.

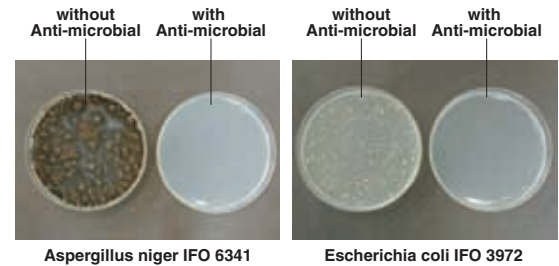

In tests conducted at the Mitsubishi Heavy Industries Nagoya Research Lab, 24 hrs after contact with bacteria, cultured on agar media.

### Live Bacteria Count on Measured Test Pieces

Tested Contaminant	Measurement	Test Pieces	Bacteria Count Per Test Piece		
			Measurement 1	Measurement 2	Measurement 3
Escherichia coli IFO 3972 coli	Immediately after contact	Not treated	$1.9 \times 10^5$	$1.6 \times 10^5$	$1.3 \times 10^5$
	After 24 hrs at 35°C	Test piece 1 Not treated	<10 $3.8 \times 10^6$	<10 $4.9 \times 10^6$	<10 $7.2 \times 10^6$
Staphylococcus aureus	Immediately after contact	Not treated	$1.4 \times 10^5$	$1.6 \times 10^5$	$1.3 \times 10^5$
	After 24 hrs at 35°C	Test piece 1 Not treated	<10 $8.6 \times 10^5$	<10 $4.5 \times 10^5$	<10 $3.6 \times 10^5$
Aspergillus niger	Immediately after contact	Not treated	$1.5 \times 10^4$	$2.2 \times 10^4$	$1.6 \times 10^4$
	After 24 hrs at 35°C	Test piece 1 Not treated	<10 $1.0 \times 10^4$	<10 $1.2 \times 10^4$	<10 $2.5 \times 10^4$

Test Pieces 1) Products with Antimicrobial and Antifungal Treatment

## Wide Operation Range

Heating and cooling operations are possible at an outdoor temperature as low as  $-15^{\circ}\text{C}$ .

Our new advanced technology has expanded the heating and cooling operation range. This permits installation of the units considering a heating and cooling operation under a low temperature condition down to  $-15^{\circ}\text{C}$ .

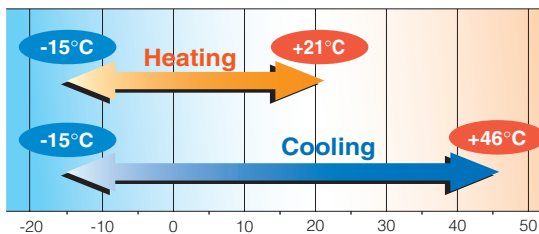

\*For the capacities under low temperature conditions, refer to technical manual.

● **Applied models**  
All inverter models (except SRK-ZJP +21°C ~ +46°C in Cooling)

Hi quality air long reach & silent flow

## Quiet Operation

This is the secret of quiet operation.

In addition to a jet airflow system delivering uniform winds to every corner, it has an optimized serration stabilizer configuration, which ensures smooth wind flow. It makes it possible to lower operation noises further by minimizing the interaction between wind flows and the fan.

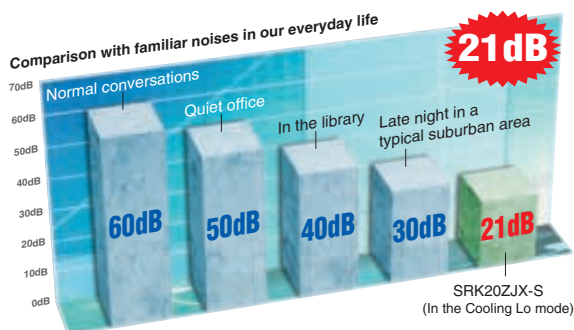

## Three Sensors

Control of room temperature and humidity is very important for people to live a comfortable life. Use of three sensors to control indoor temperature, indoor humidity and outdoor temperature enable unit to obtain optimum air-conditioning.

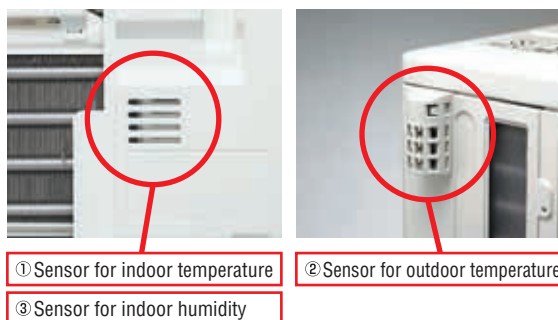

● **Applied models**  
① ② All SRK, SRF, SRR, FDTC  
③ SRK50/60ZJX, SRK-ZE, SRK35ZJR, SRK35/50ZJ, SRK35/50ZJP, SRF-ZJX

## Washable filter and easy cleaning of air inlet panel

Removing air filter is quite easy. Keeping air filter clean is effective way to save energy and to keep the original powerful performance. Air inlet panel is also removable and can be cleaned easily.

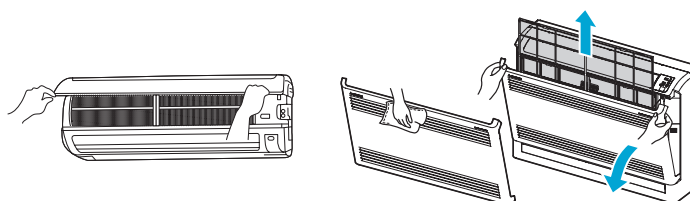

● **Applied models**  
All SRK, SRF

## Long piping length

Piping length has been extended and design flexibility has been improved.

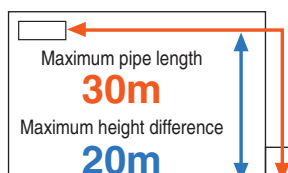

























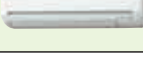







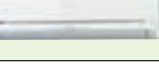









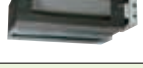

● **Applied models**  
SRK50/60ZJX, SRF50ZJX, FDTC40/50/60VD, SRK-ZE

# Product Line Up



RoHS

Model		Capacity Range (kW : Rated cooling capacity)									page	
		2.0	2.5	2.8	3.5	4.0	5.0	5.6	6.0	6.3		7.1
HEAT PUMP DC INVERTER	SRK-ZJX   ※	 20ZJX-S	 25ZJX-S		 35ZJX-S		 50ZJX-S		 60ZJX-S			14
	SRK-ZE  									 63ZE-S1	 71ZE-S1	16
	SRK-ZJR   ※		 25ZJR-S		 35ZJR-S							17
	SRK-ZJ   ※	 20ZJ-S	 25ZJ-S		 35ZJ-S		 50ZJ-S					18
	SRK-ZJP  		 25ZJP-S		 35ZJP-S		 50ZJP-S					19
HEAT PUMP CONSTANT SPEED	SRK-HG 	 20HG-S		 28HG-S		 40HG-S						20
	SRK-HE 						 50HE-S1	 56HE-S1		 63HE-S1	 71HE-S1	21
HEAT PUMP DC INVERTER	SRF-ZJX  ※		 25ZJX-S		 35ZJX-S		 50ZJX-S					22
	SRR-ZJ  ※		 25ZJ-S		 35ZJ-S							24
	FDTC-VD  ※		 25VD		 35VD	 40VD	 50VD		 60VD			25

Model		2.0	2.5	3.5	4.0	4.5	5.0	6.0	7.1	8.0	page	
INVERTER Free-Multi	SRK-ZJX   ※	 20ZJX-S	 25ZJX-S	 35ZJX-S			 50ZJX-S	 60ZJX-S			28	
	SRK-ZJR   ※		 25ZJR-S	 35ZJR-S							28	
	SRK-ZJ   ※	 20ZJ-S	 25ZJ-S	 35ZJ-S				 50ZJ-S				29
	SRF-ZJX  ※		 25ZJX-S	 35ZJX-S			 50ZJX-S				29	
	SRR-ZJ  ※		 25ZJ-S	 35ZJ-S			 50ZJ-S	 60ZJ-S			30	
	FDTC-VD  ※ <small>600 x 600 Super Compact type</small>		 25VD	 35VD			 50VD	 60VD			30	
OUTDOOR UNIT SCM					 40ZJ-S	 45ZJ-S	 50ZJ-S	 60ZJ-S			27	
									 71ZJ-S	 80ZJ-S	27	

※ common to the both cases

## Clean Operation / Filter



### Allergen Clear System

The operation is operated for 2 hours after the unit has stopped its normal operation. The indoor unit is dried up and growth of mold is restrained.



### Allergen Clear Filter

The filter breaks down the pollen, lice, and all allergens that live on cat skins, etc. and deactivates them.



### Natural Enzyme Filter

Enzymes used in the filter are naturally occurring lytic enzymes which attack cell walls of microorganisms trapped on the filter and destroy them.



### Self Clean Operation

The system is equipped to suppress the influence of the allergen caught by the filter by controlled the temperature and humidity.



### Photocatalytic Washable Deodorizing Filter

It keeps air fresh by deodorizing the molecules causing odor. The deodorizing ability can be easily restored simply by cleaning and exposing to the sunlight.

## Comfortable Functions



### Fuzzy Auto Mode

Automatically, the unit determines its operating mode and temperature setting based on a fuzzy calculation, and adjusts the inverter frequency.



### "HI POWER" Operation

The unit can operate continuously in "HI POWER" mode for 15 minutes. This mode is convenient to reach the desired temperature quickly.



### Three "Hot" System

This series offers three "hot" systems. "Hot start" allows the unit to begin operating immediately, while the "hot spurt" fast-heating system works to increase the temperature setting by two degrees. The "hot keep" system is used during automatic defrosting or to prevent the influx of cool air. These three operational control systems help ensure comfortable and efficient heating.



### Automatic Operation

The air conditioner automatically selects from among heating, cooling and dry operations.

## Comfortable Air Flow Functions



### 3D Auto

You can choose the best cooling or heating pattern by only pushing one button.



### Air Scroll

The swing of the flap causes the air flow to spiral as it reaches the floor, and breeze reaches all of a room.



### Up/Down Flap Swing

Flap moves up and down continuously. The Up/Down flap swing can be fixed at the preferred operation angle.



### Auto Flap Mode

Whatever the operating mode is, the unit automatically selects the optimal angle.

**COOLING & DRY**  
Horizontal blowing



**HEATING**  
Slant forward blowing



Red line : moves quickly  
Black line : moves slowly

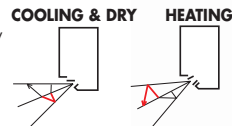

### Right/Left Louver swing

Louver moves right and left continuously. The Right/Left louver swing can be fixed at the preferred operation angle.



### Memory Flap

While the flap is swinging, it can be stopped at any angle desired. The flap returns to the position that it was in when operation last stopped.



### Positioning of Installation

You can set the left-right air flow directions when you installed the air conditioner near the side wall by remote controller operation.



### Air Outlet Selection

Both lower and upper air outlets and upper air outlet can be selected.

## Convenience & Economy Functions



### On Timer

This facility enables the operation to start a little earlier, so that the room approaches optimum temperature at ON time when the operation is started by ON-TIMER. Thus it will try to be at the temperature you want, when you want.



### Dry Operation

The unit dehumidifies the room by intermittent cooling operation.



### Off Timer

The unit stops automatically at the set time.



### Economy Mode

The unit realizes effective energy saving operation, while still keeping a comfortable cooling and heating condition.



### 24-hour On/Off Programmable Timer

By combining a start timer with a stop timer, you can register two timer operations a day. Once set, timers will faithfully start or stop the system at a specified time of the day repeatedly.



### Sleep Mode

The room temperature is automatically controlled during the set sleep mode period, ensuring that room temperature will not get too cold or too hot.

## Maintenance & Prevention Functions



### Microcomputer-Operated Defrosting

This mode automatically eliminates frost, and helps minimize excessive operation in other modes.



### Detachable Indoor Air Inlet Panel

The air inlet panel on the indoor unit opens and closes easily, making filter cleaning simple. The suction panel can also be removed.



### Self-Diagnostic Function

In the case that the air conditioner malfunctions, an internal microcomputer automatically runs a self-diagnosis. (Inspection and repair should be performed by authorized dealers.)

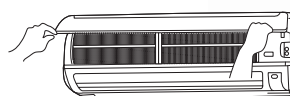

When removing the air inlet panel for internal cleaning or others, open the grill by 65 degrees and then pull it to this side.

## Others



### Back-up Switch

On the main unit, there is a backup on/off switch, which is useful when you can't use remote control, or batteries are flat.



### 24-hour ION

Tourmaline-coated sheet generates negative ions around the clock. Even when the air conditioner is not running, it generates as many negative ions as a forest, stream or fall does, allowing you to experience them without incurring any electricity charges.



### Luminous Button

With wireless "Luminous" remote controls that even "glow in the dark", it is possible to operate all desired functions of the unit with the click of a button.



### Auto Restart Function

Power blackout auto restart function is a function that records the operational status of the air-conditioner immediately prior to it being switched off by a power cut, and then automatically resumes operations at that point after the power has been restored.

# INVERTER HEAT PUMP MODEL (High COP)



# SRK-ZJX

Wall Mounted type



**NEW** SRK20ZJX-S, SRK25ZJX-S, SRK35ZJX-S  
SRK50ZJX-S, SRK60ZJX-S



All SRK-ZJX series can be selected for use as indoor units in the combination with SCM Multi system outdoor unit.



SRK50/60ZJX-S can be selected for use as indoor units in the combination with V Multi system outdoor unit. Refer to our PAC brochure for details.



Standard equipment



SRC20ZJX-S, SRC25ZJX-S, SRC35ZJX-S



SRC50ZIX-S, SRC60ZIX-S

## FUNCTION



### Comfortable Air Flow Functions



### Convenient & Economy Functions



### Maintenance & Prevention Functions



### Others



## Refrigerant pipe length

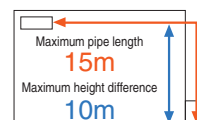

SRK20ZJX-S  
SRK25ZJX-S  
SRK35ZJX-S

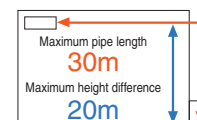

SRK50ZJX-S  
SRK60ZJX-S

## SPECIFICATIONS

Model (Indoor unit/Outdoor unit)		SRK20ZJX-S SRC20ZJX-S	SRK25ZJX-S SRC25ZJX-S	SRK35ZJX-S SRC35ZJX-S	SRK50ZJX-S SRC50ZIX-S	SRK60ZJX-S SRC60ZIX-S
Power supply		1Phase, 220/230/240V, 50Hz				
Cooling capacity	ISO-T1 (JIS)	kW	2.0(0.9~3.1)	2.55(0.9~3.2)	3.5(0.9~4.1)	5.0(0.7~6.2)
Heating capacity	ISO-T1 (JIS)	kW	2.5(0.9~4.3)	3.13(0.9~4.7)	4.3(0.9~5.1)	6.0(0.7~8.8)
Cooling input	at 230V	kW	0.35(0.19~0.70)	0.49(0.19~0.82)	0.845(0.19~1.01)	1.30(0.2~2.20)
Heating input	at 230V	kW	0.45(0.23~1.00)	0.595(0.23~1.12)	0.96(0.23~1.35)	1.35(0.2~2.26)
Cooling energy label			A			
Heating energy label			A			
EER (In cooling)			5.71	5.20	4.14	3.85
COP (In heating)			5.56	5.26	4.48	4.44
Running current	Cooling	A	1.9/1.8/1.7	2.5/2.4/2.3	4.0/3.8/3.6	6.0/5.7/5.5
	Heating	A	2.4/2.3/2.2	3.1/2.9/2.8	4.6/4.4/4.2	6.2/5.9/5.7
Sound power level *	Cooling(Indoor/Outdoor)	dB(A)	53/60	55/60	58/63	60/62
	Heating(Indoor/Outdoor)	dB(A)	54/59	58/60	59/62	62/62
Sound pressure level *	Cooling(Indoor)	dB(A)	Hi:39 Me:30 Lo:21	Hi:41 Me:31 Lo:22	Hi:43 Me:33 Lo:22	Hi:45 Me:38 Lo:26
	Heating(Indoor)	dB(A)	Hi:38 Me:33 Lo:25	Hi:41 Me:34 Lo:27	Hi:42 Me:35 Lo:27	Hi:45 Me:38 Lo:32
	Indoor	CMM	Hi:11.5 Me:8.0 Lo:5.0	Hi:12.5 Me:9.0 Lo:5.0	Hi:13.5 Me:9.5 Lo:5.0	Hi:13.5 Me:11.0 Lo:8.0
	Heating		Hi:12.0 Me:9.5 Lo:7.5	Hi:13.0 Me:10.0 Lo:7.5	Hi:14.0 Me:11.0 Lo:8.0	Hi:16.5 Me:14.5 Lo:10.5
	Outdoor		Cooling:29.5 Heating:27.0	Cooling:32.5 Heating:29.5	Cooling:36.0 Heating:33.0	Cooling:41.5 Heating:36.0
Exterior dimensions (H×W×D)	Indoor	mm	309×890×220			
	Outdoor	mm	595×780(+62)×290			640×800(+71)×290
Net weight	Indoor/Outdoor	kg	15/38			15/43
Refrigerant piping	O.D.	mm(in)	φ 6.35(1/4")			φ 12.7(1/2")
	Liquid line		φ 9.52(3/8")			
	Gas line	mm(in)	φ 9.52(3/8")			
	Connecting method		Flare connecting			
Refrigerant			R410A			
Clean filter			Allergen Clear Filter × 1, Photocatalytic Washable Deodorizing Filter × 1			

The data are measured under the following conditions(ISO-T1). Cooling: Indoor temp. of 27°CDB, 19°CWB, and outdoor temp. of 35°CDB. Heating: Indoor temp. of 20°CDB, and outdoor temp. of 7°CDB, 6°CWB. \* Indicates the value in anechoic chamber. During operation these values are somewhat higher due to ambient conditions.

# The industry's highest COP levels

Our new models, SRK20/25/35ZJX-S have reached the highest level of COP (coefficient of performance) in the industry with full model change both of indoor and outdoor units, utilizing advanced technologies which have been applied for our larger models SRK50/60ZJX-S.

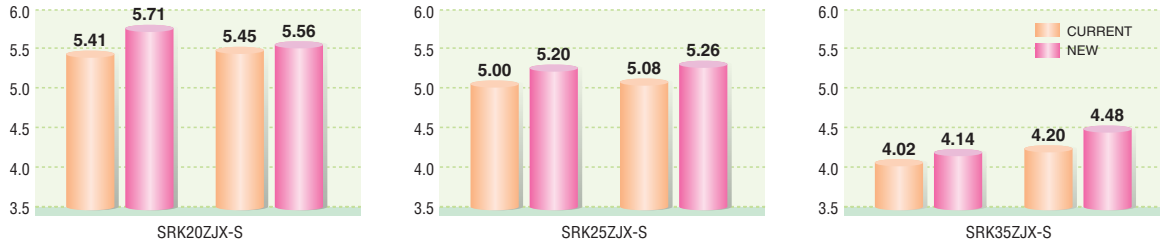

## Movable air inlet panel

Applying a movable air inlet panel, minimization of air resistance and advanced design are realized.

## Unification of indoor unit design

All the ZJX series have the same design for indoor units with a sophisticated flat front panel.



## Remote control

### Operation section

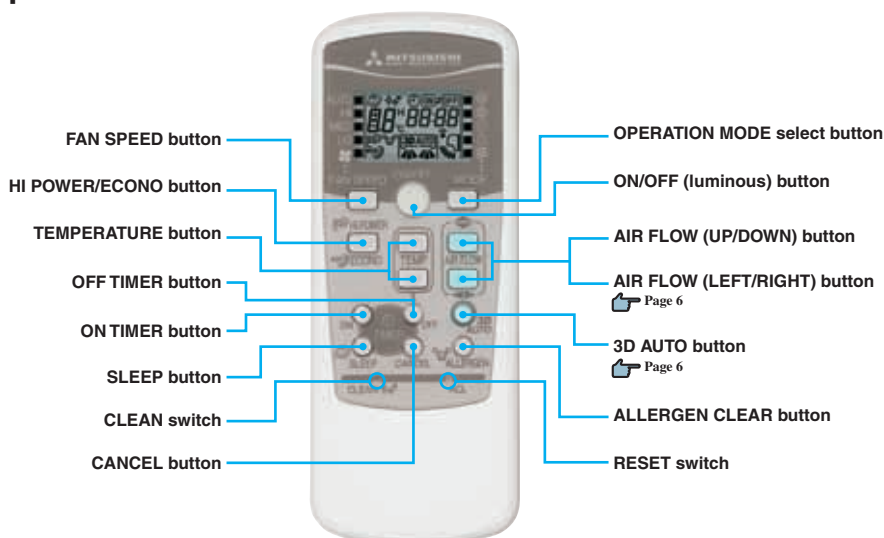

The above illustration shows all controls, but in practice only the relevant parts are shown.

# INVERTER HEAT PUMP MODEL (High COP)



# SRK-ZE

Wall Mounted type



SRK63ZE-S1, SRK71ZE-S1



Standard equipment



SRC63ZE-S1, SRC71ZE-S1

## Refrigerant pipe length

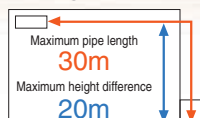

SRK63ZE-S1  
SRK71ZE-S1

## FUNCTION



### Comfortable Functions



### Comfortable Air Flow Functions



### Convenient & Economy Functions



### Maintenance & Prevention Functions



### Others



## SPECIFICATIONS

Item	Model (Indoor unit/Outdoor unit)		SRK63ZE-S1 SRC63ZE-S1	SRK71ZE-S1 SRC71ZE-S1
	Power supply			1Phase, 220/230/240V, 50Hz
Cooling capacity	ISO-T1(JIS)	kW	6.3(0.9~7.1)	7.1(0.9~8.0)
Heating capacity	ISO-T1(JIS)	kW	7.1(0.9~9.0)	8.0(0.9~10.5)
Cooling input	at 230V	kW	1.84(0.32~2.33)	2.21(0.32~2.98)
Heating input	at 230V	kW	1.86(0.26~2.62)	2.21(0.26~3.75)
Cooling energy label			A	
Heating energy label			A	
EER (In cooling)			3.42	3.21
COP (In heating)			3.82	3.62
Running current	Cooling	A	8.4/8.1/7.7	10.1/9.7/9.3
	Heating	A	8.5/8.2/7.8	10.1/9.7/9.3
Sound power level*	Cooling(Indoor/Outdoor)	dB(A)	58/62	60/67
	Heating(Indoor/Outdoor)	dB(A)	59/63	60/64
Sound pressure level *	Cooling(Indoor)	dB(A)	Hi:43 Me:39 Lo:33 UL0:26	Hi:45 Me:40 Lo:34 UL0:26
	Heating(Indoor)	dB(A)	Hi:44 Me:38 Lo:32 UL0:27	Hi:46 Me:40 Lo:34 UL0:27
Air flow(at Hi)	Indoor	Cooling	18.5	20.0
		Heating	21.0	22.5
	Outdoor		Cooling:46.0 Heating:46.0	Cooling:56.0 Heating:46.0
Exterior dimensions (H×W×D)	Indoor	mm	318×1098×248	
	Outdoor	mm	750×880(+88)×340	
Net weight	Indoor/Outdoor	kg	15/59	
Refrigerant piping	O.D	Liquid line	φ 6.35 (1/4")	
		Gas line	φ 15.88(5/8")	
	Connecting method		Flare connecting	
Refrigerant			R410A	
Clean filter			Allergen Clear Filter X 1, Photocatalytic Washable Deodorizing Filter X 1	

The data are measured under the following conditions(ISO-T1). Cooling: Indoor temp. of 27°CDB, 19°CWB, and outdoor temp. of 35°CDB. Heating: Indoor temp. of 20°CDB, and outdoor temp. of 7°CDB, 6°CWB. \* Indicates the value in an anechoic chamber. During operation these values are somewhat higher due to ambient conditions.

# INVERTER HEAT PUMP MODEL (High COP)

Premium Plus Series

# SRK-ZJR

Wall Mounted type



**NEW**

SRK25ZJR-S, SRK35ZJR-S



SRK25/35ZJR-S can be selected for use as indoor units in the combination with SCM Multi system outdoor unit.



Standard equipment



SRK25ZJR-S, SRC35ZJR-S

## Refrigerant pipe length

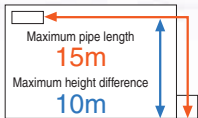

SRK25ZJR-S  
SRK35ZJR-S

## FUNCTION



Comfortable Functions



Comfortable Air Flow Functions



Convenient & Economy Functions



Maintenance & Prevention Functions



Others



## SPECIFICATIONS

Model (Indoor unit/Outdoor unit)			SRK25ZJR-S SRC25ZJR-S	SRK35ZJR-S SRC35ZJR-S
Power supply			1Phase, 220/230/240V, 50Hz	
Cooling capacity	ISO-T1(JIS)	kW	2.5(1.0~2.9)	3.5(1.0~3.8)
Heating capacity	ISO-T1(JIS)	kW	3.2(1.2~4.6)	4.0(1.3~4.8)
Cooling input	at 230V	kW	0.575(0.21~0.81)	0.965(0.21~1.20)
Heating input	at 230V	kW	0.70(0.27~1.36)	0.995(0.29~1.45)
Cooling energy label			A	
Heating energy label			A	
EER (In cooling)			4.35	3.63
COP (In heating)			4.57	4.02
Running current	Cooling	A	3.0/2.9/2.8	4.6/4.4/4.2
	Heating	A	3.5/3.3/3.2	4.6/4.4/4.2
Sound power level *	Cooling(Indoor/Outdoor)	dB(A)	49/58	57/60
	Heating(Indoor/Outdoor)	dB(A)	55/59	58/61
Sound pressure level *	Cooling(Indoor)	dB(A)	Hi:34 Me:28 Lo:21	Hi:41 Me:32 Lo:22
	Heating(Indoor)	dB(A)	Hi:39 Me:31 Lo:24	Hi:42 Me:37 Lo:25
Air flow	Indoor	Cooling	Hi:7.9 Me:6.0 Lo:5.0	Hi:10.1 Me:6.4 Lo:5.0
		Heating	Hi:11.0 Me:6.5 Lo:5.1	Hi:12.8 Me:9.4 Lo:6.1
	Outdoor	CMM	Cooling:29.5 Heating:27.0	Cooling:32.5 Heating:29.5
Exterior dimensions (H×W×D)	Indoor	mm	294×798×229	
	Outdoor	mm	595×780(+62)×290	
Net weight	Indoor/Outdoor	kg	9.5/38	
Refrigerant piping	O.D	Liquid line	φ 6.35 (1/4")	
		Gas line	φ 9.52 (3/8")	
	Connecting method			Flare connecting
Refrigerant			R410A	
Clean filter			Allergen Clear Filter × 1, Photocatalytic Washable Deodorizing Filter × 1	

The data are measured under the following conditions(ISO-T1). Cooling: Indoor temp. of 27°CDB, 19°CWB, and outdoor temp. of 35°CDB. Heating: Indoor temp. of 20°CDB, and outdoor temp. of 7°CDB, 6°CWB. \* Indicates the value in an anechoic chamber. During operation these values are somewhat higher due to ambient conditions.

# INVERTER HEAT PUMP MODEL (High COP)



# SRK-ZJ

Wall Mounted type



SRK20ZJ-S, SRK25ZJ-S  
SRK35ZJ-S, SRK50ZJ-S



All SRK-ZJ series can be selected for use as indoor units in the combination with SCM Multi system outdoor unit.

## Refrigerant pipe length

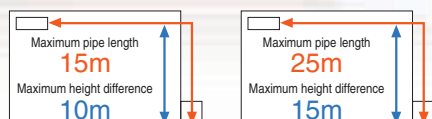

SRK20ZJ-S, SRK25ZJ-S  
SRK35ZJ-S

SRK50ZJ-S



Standard equipment



SRC20ZJ-S, SRC25ZJ-S  
SRC35ZJ-S



SRC50ZJ-S

## FUNCTION



### Comfortable Functions



### Comfortable Air Flow Functions



### Convenient & Economy Functions



### Maintenance & Prevention Functions



### Others



## SPECIFICATIONS

Model (Indoor unit/Outdoor unit)		SRK20ZJ-S SRC20ZJ-S	SRK25ZJ-S SRC25ZJ-S	SRK35ZJ-S SRC35ZJ-S	SRK50ZJ-S SRC50ZJ-S		
Power supply		1Phase, 220/230/240V, 50Hz					
Cooling capacity	ISO-T1 (JIS)	kW	2.0(1.0~2.7)	2.5(1.0~2.9)	3.5(1.0~3.8)	5.0(1.6~5.5)	
Heating capacity	ISO-T1 (JIS)	kW	2.7(1.2~3.9)	3.2(1.2~4.2)	4.0(1.3~4.8)	5.8(1.6~6.6)	
Cooling input	at 230V	kW	0.44(0.21~0.77)	0.62(0.21~0.88)	1.01(0.21~1.24)	1.55(0.40~2.20)	
Heating input	at 230V	kW	0.62(0.27~1.38)	0.80(0.27~1.36)	1.00(0.29~1.45)	1.59(0.42~2.10)	
Cooling energy label	A						
Heating energy label	A						
EER (In cooling)			4.55	4.03	3.47	3.23	
COP (In heating)			4.35	4.00	4.00	3.65	
Running current	Cooling	A	2.5/2.4/2.3	3.2/3.1/3.0	4.9/4.7/4.5	7.1/6.8/6.5	
	Heating	A	3.2/3.1/3.0	4.0/3.8/3.7	4.9/4.7/4.5	7.3/7.0/6.7	
Sound power level *	Cooling(Indoor/Outdoor)	dB(A)	49/59	50/60	58/62	61/61	
	Heating(Indoor/Outdoor)	dB(A)	52/58	55/61	59/63	61/63	
Sound pressure level *	Cooling(Indoor)	dB(A)	Hi:33 Me:27 Lo:21	Hi:34 Me:28 Lo:21	Hi:42 Me:32 Lo:22	Hi:46 Me:37 Lo:26	
	Heating(Indoor)	dB(A)	Hi:36 Me:31 Lo:24	Hi:39 Me:31 Lo:24	Hi:43 Me:37 Lo:25	Hi:45 Me:37 Lo:31	
Air flow	Indoor	CMM	Cooling	Hi:7.8 Me:5.6 Lo:4.8	Hi:7.9 Me:6.0 Lo:5.0	Hi:10.1 Me:6.4 Lo:5.0	Hi:11.3 Me:7.8 Lo:5.3
	Heating		Hi:9.8 Me:6.3 Lo:5.0	Hi:10.6 Me:6.5 Lo:5.1	Hi:12.8 Me:9.4 Lo:6.1	Hi:13.5 Me:10.2 Lo:7.5	
Outdoor			Cooling:29.5 Heating:25.6	Cooling:32.1 Heating:25.6	Cooling:31.5 Heating:27.8	Cooling:36.0 Heating:36.0	
Exterior dimensions (H×W×D)	Indoor	mm	294×798×229				
	Outdoor	mm	540×780(+62)×290			640×800(+71)×290	
Net weight	Indoor/Outdoor	kg	9.5/32		9.5/35	9.5/42	
Refrigerant piping	O.D	Liquid line	φ 6.35 (1/4")				
		Gas line	φ 9.52 (3/8")			φ 12.7 (1/2")	
	Connecting method		Flare connecting				
Refrigerant	R410A						
Clean filter	Allergen Clear Filter × 1, Photocatalytic Washable Deodorizing Filter × 1						

The data are measured under the following conditions(ISO-T1). Cooling: Indoor temp. of 27°CDB, 19°CWB, and outdoor temp. of 35°CDB. Heating: Indoor temp. of 20°CDB, and outdoor temp. of 7°CDB, 6°CWB.  
\* Indicates the value in anechoic chamber. During operation these values are somewhat higher due to ambient conditions.

# INVERTER HEAT PUMP MODEL



# SRK-ZJP

Wall Mounted type



SRK25ZJP-S, SRK35ZJP-S  
SRK50ZJP-S



Standard equipment



SRC25ZJP-S  
SRC35ZJP-S



SRC50ZJP-S

## Refrigerant pipe length

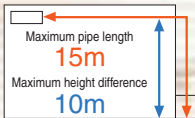

SRK25ZJP-S  
SRK35ZJP-S

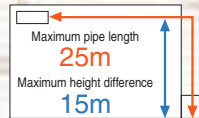

SRK50ZJP-S

## FUNCTION



Comfortable Functions



Comfortable Air Flow Functions



Convenient & Economy Functions



Maintenance & Prevention Functions



Others



## SPECIFICATIONS

Model (Indoor unit/Outdoor unit)		SRK25ZJP-S SRC25ZJP-S	SRK35ZJP-S SRC35ZJP-S	SRK50ZJP-S SRC50ZJP-S
Power supply		1Phase, 220/230/240V, 50Hz		
Cooling capacity	ISO-T1 (JIS)	kW	2.5(1.0~2.7)	3.5(1.0~3.7)
Heating capacity	ISO-T1 (JIS)	kW	3.2(1.2~4.2)	4.0(1.3~4.8)
Cooling input	at 230V	kW	0.71(0.21~0.88)	1.06(0.21~1.24)
Heating input	at 230V	kW	0.86(0.27~1.46)	1.09(0.29~1.58)
Cooling energy label	A			
Heating energy label	A			
EER	Cooling		3.52	3.30
COP	Heating		3.72	3.67
Running current	Cooling	A	3.6/3.4/3.3	5.1/4.9/4.6
	Heating	A	4.2/4.0/3.9	5.2/5.0/4.8
Sound power level *	Cooling(Indoor/Outdoor)	dB(A)	52/56	54/59
	Heating(Indoor/Outdoor)	dB(A)	51/58	57/61
Sound pressure level *	Cooling(Indoor)	dB(A)	Hi:36 Me:30 Lo:22	Hi:39 Me:32 Lo:23
	Heating(Indoor)	dB(A)	Hi:35 Me:30 Lo:26	Hi:41 Me:36 Lo:27
Air flow	Indoor	CMM	Cooling: Hi:8.0 Me:6.2 Lo:4.5	Hi:8.5 Me:6.8 Lo:4.6
	Heating		Hi:9.3 Me:7.8 Lo:6.6	Hi:11.0 Me:8.4 Lo:6.8
	Outdoor		Cooling:29.5 Heating:25.6	Cooling:27.8 Heating:27.8
Exterior dimensions (H×W×D)	Indoor	mm	268×790×224	
	Outdoor	mm	540×780(+62)×290	
Net weight	Indoor/Outdoor	kg	8.5/32	8.5/35
Refrigerant piping size	O.D	Liquid line	mm(in)	φ 6.35 (1/4")
		Gas line	mm(in)	φ 9.52 (3/8")
Refrigerant	R410A			
Clean filter	-			

The data are measured under the following conditions(ISO-T1). Cooling: Indoor temp. of 27°CDB, 19°CWB, and outdoor temp. of 35°CDB. Heating: Indoor temp. of 20°CDB, and outdoor temp. of 7°CDB, 6°CWB.  
\* Indicates the value in an anechoic chamber. During operation these values are somewhat higher due to ambient conditions.

# CONSTANT SPEED HEAT PUMP MODEL

# SRK-HG

Wall Mounted type



SRK20HG-S  
SRK28HG-S



SRK20HG-S, SRK28HG-S, SRK40HG-S

## Refrigerant pipe length

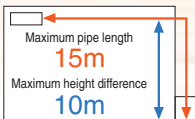

SRK20HG-S  
SRK28HG-S  
SRK40HG-S



Standard equipment



SRC20HG-S, SRC28HG-S,  
SRC40HG-S

## FUNCTION



Comfortable Functions



Comfortable Air Flow Functions



Convenient & Economy Functions



Maintenance & Prevention Functions



Others



## SPECIFICATIONS

Model (Indoor unit/Outdoor unit)			SRK20HG-S SRC20HG-S	SRK28HG-S SRC28HG-S	SRK40HG-S SRC40HG-S
Power supply	1Phase, 220/230/240V, 50Hz				
Cooling capacity	ISO-T1 (JIS)	kW	2.07	2.6	3.6
Heating capacity	ISO-T1 (JIS)	kW	2.22	2.8	3.92
Cooling input	at 230V	kW	0.64	0.81	1.12
Heating input	at 230V	kW	0.61	0.77	1.15
Cooling energy label	A				
Heating energy label	A				
EER (In cooling)			3.23	3.21	3.21
COP (In heating)			3.64	3.64	3.41
Running current	Cooling	A	3.1/3.0/2.9	3.8/3.7/3.6	5.3/5.2/5.1
	Heating	A	3.0/2.9/2.8	3.7/3.5/3.3	5.4/5.3/5.2
Sound power level *	Cooling(Indoor/Outdoor)	dB(A)	52/60	55/60	56/63
	Heating(Indoor/Outdoor)	dB(A)	52/60	56/60	57/66
Sound pressure level *	Cooling(Indoor)	dB(A)	Hi:34 Me:30 Lo:27	Hi:39 Me:33 Lo:30	Hi:40 Me:38 Lo:34
	Heating(Indoor)	dB(A)	Hi:34 Me:31 Lo:27	Hi:40 Me:33 Lo:29	Hi:40 Me:38 Lo:34
Air flow(Hi)	Indoor	Cooling	7.5	8.5	9.0
		Heating	7.5	10	10.0
	Outdoor	Cooling:27 Heating:27	Cooling:29 Heating:29	Cooling:32.0 Heating:32.0	
Exterior dimensions (H×W×D)	Indoor	mm	268×790×199		
	Outdoor	mm	540×780(+62)×290		
Net weight	Indoor/Outdoor	kg	8.5/29	8.5/31	8.5/38
Refrigerant piping	O.D	Liquid line	φ 6.35 (1/4")		
		Gas line	φ 9.52 (3/8")		
	Connecting method		Flare connecting		
Refrigerant	R410A				
Clean filter	Natural Enzyme Filter×1 Photocatalytic Washable Deodorizing Filter×1				

The data are measured under the following conditions(ISO-T1). Cooling: Indoor temp. of 27°CDB, 19°CWB, and outdoor temp. of 35°CDB. Heating: Indoor temp. of 20°CDB, and outdoor temp. of 7°CDB, 6°CWB.  
\* Indicates the value in an anechoic chamber. During operation these values are somewhat higher due to ambient conditions.

# CONSTANT SPEED HEAT PUMP MODEL

# SRK-HE

Wall Mounted type



SRK50HE-S1  
SRK56HE-S1  
SRK71HE-S1



SRK50HE-S1, SRK56HE-S1



Standard equipment



SRK63HE-S1, SRK71HE-S1



Standard equipment

## Refrigerant pipe length

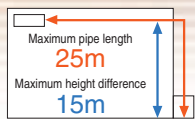

SRK50HE-S1 SRK63HE-S1  
SRK56HE-S1 SRK71HE-S1



SRC50HE-S1, SRC56HE-S1,  
SRC63HE-S1



SRC71HE-S1

## FUNCTION



### Comfortable Air Flow Functions



### Convenient & Economy Functions



### Maintenance & Prevention Functions



### Others



## SPECIFICATIONS

Model (Indoor unit/Outdoor unit)			SRK50HE-S1 SRC50HE-S1	SRK56HE-S1 SRC56HE-S1	SRK63HE-S1 SRC63HE-S1	SRK71HE-S1 SRC71HE-S1
Power supply	1Phase, 220/230/240V, 50Hz					
Cooling capacity	ISO-T1 (JIS)	kW	4.7	5.1	6.3	7.1
Heating capacity	ISO-T1 (JIS)	kW	5.3	5.8	6.7	7.5
Cooling input	at 230V	kW	1.41	1.59	2.19	2.21
Heating input	at 230V	kW	1.40	1.58	1.85	2.07
Cooling energy label	A					
Heating energy label	A					
EER (In cooling)			3.33	3.21	2.88	3.21
COP (In heating)			3.79	3.67	3.62	3.62
Running current	Cooling	A	6.5/6.3/6.0	7.3/7.1/6.8	10.9/10.5/10.0	11.0/10.6/10.1
	Heating	A	6.5/6.2/6.0	7.4/7.1/6.8	9.2/8.8/8.5	10.3/9.9/9.5
Sound power level *	Cooling(Indoor/Outdoor)	dB(A)	58/63	59/64	59/65	59/69
	Heating(Indoor/Outdoor)	dB(A)	61/64	61/65	60/65	60/70
Sound pressure level *	Cooling(Indoor)	dB(A)	Hi:43 Me:39 Lo:34	Hi:44 Me:40 Lo:35	Hi:44 Me:40 Lo:37	Hi:45 Me:41 Lo:38
	Heating(Indoor)	dB(A)	Hi:44 Me:39 Lo:35	Hi:44 Me:39 Lo:35	Hi:45 Me:41 Lo:37	Hi:46 Me:41 Lo:38
Air flow(Hi)	Indoor	Cooling	10		11.0	18.0
		Heating	12.5		12.5	20.5
	Outdoor		Cooling:38.0 Heating:38.0	Cooling:38.0 Heating:38.0	Cooling:42.0 Heating:42.0	Cooling:60.0 Heating:60.0
Exterior dimensions (H×W×D)	Indoor	mm	298×840×259			318×1098×248
	Outdoor	mm	640×850(+65)×290			750×880(+88)×340
Net weight	Indoor/Outdoor	kg	12/44	12/44	15/47	15/68
Refrigerant piping	O.D	Liquid line	φ 6.35 (1/4")			
		Gas line	φ 12.7 (1/2")			
	Connecting method		Flare connecting			
Refrigerant	R410A					
Clean filter	Natural Enzyme Filter×1 Photocatalytic Washable Deodorizing Filter×1					

The data are measured under the following conditions(ISO-T1). Cooling: Indoor temp. of 27°CDB, 19°CWB, and outdoor temp. of 35°CDB. Heating: Indoor temp. of 20°CDB, and outdoor temp. of 7°CDB, 6°CWB. \* Indicates the value in an anechoic chamber. During operation these values are somewhat higher due to ambient conditions.

# INVERTER HEAT PUMP MODEL (High COP)

# SRF-ZJX

Floor type



Standard equipment



SRC25ZJX-S, SRC35ZJX-S



SRC50ZIX-S



SRF25ZJX-S, SRF35ZJX-S, SRF50ZJX-S



All SRF-ZJX series can be selected for use as indoor units in the combination with SCM Multi system outdoor unit.

## The highest COP level in the industry

Our experience, research and development efforts with the floor standing series have realized the highest COP level in the industry and all models clear A class level by wide margin. Indoor units are totally new design with optimum balance of air outlet direction and sufficient air flow volume.

### FUNCTION



#### Convenient & Economy Functions



#### Maintenance & Prevention Functions



#### Others



### EER in Cooling

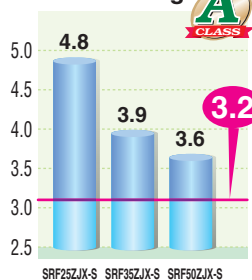

### COP in Heating

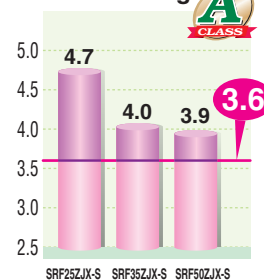

### Refrigerant pipe length

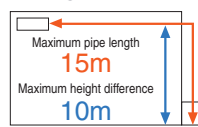

SRF25ZJX-S, SRF35ZJX-S

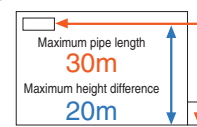

SRF50ZJX-S

### SPECIFICATIONS

Model (Indoor unit/Outdoor unit)		SRF25ZJX-S SRC25ZJX-S	SRF35ZJX-S SRC35ZJX-S	SRF50ZJX-S SRC50ZIX-S
Power supply		1Phase, 220/230/240V, 50Hz		
Cooling capacity	ISO-T1 (JIS) kW	2.5(0.9~3.2)	3.5(0.9~4.1)	5.0(0.7~5.5)
Heating capacity	ISO-T1 (JIS) kW	3.4(0.9~4.7)	4.5(0.9~5.1)	6.0(0.7~7.0)
Cooling input	at 230V kW	0.521(0.19~0.82)	0.890(0.19~1.26)	1.390(0.2~1.80)
Heating input	at 230V kW	0.723(0.23~1.20)	1.124(0.23~1.43)	1.540(0.2~2.25)
Cooling energy label		A		
Heating energy label		A		
EER (In cooling)		4.80	3.93	3.60
COP (In heating)		4.70	4.00	3.90
Running current	Cooling	A	2.6/2.5/2.4	6.4/6.1/5.8
	Heating	A	3.6/3.4/3.3	7.1/6.8/6.5
Sound power level *	Cooling(Indoor/Outdoor)	dB(A)	51/60	58/62
	Heating(Indoor/Outdoor)	dB(A)	51/60	58/62
Sound pressure level *	Cooling(Indoor)	dB(A)	Hi:40 Me:32 Lo:26	Hi:47 Me:39 Lo:30
	Heating(Indoor)	dB(A)	Hi:40 Me:35 Lo:28	Hi:47 Me:39 Lo:32
Air flow	Indoor	Cooling	CMM	Hi:9.0 Me:7.6 Lo:5.8
		Heating	CMM	Hi:10.5 Me:8.2 Lo:6.6
	Outdoor		Cooling:29.5 Heating:27.0	Cooling:32.5 Heating:29.5
Exterior dimensions (H×W×D)	Indoor	mm	600×860×238	
	Outdoor	mm	595×780(+62)×290	
Net weight	Indoor/Outdoor	kg	18/38	19/43
Refrigerant piping	O.D	Liquid line	mm(in) φ 6.35 (1/4")	
		Gas line	mm(in) φ 9.52 (3/8")	
	Connecting method		Flare connecting	
Refrigerant			R410A	
Clean filter			Natural Enzyme Filter×1 Photocatalytic Washable Deodorizing Filter×1	

The data are measured under the following conditions(ISO-T1). Cooling: Indoor temp. of 27°CDB, 19°CWB, and outdoor temp. of 35°CDB. Heating: Indoor temp. of 20°CDB, and outdoor temp. of 7°CDB, 6°CWB. \* Indicates the value in an anechoic chamber. During operation these values are somewhat higher due to ambient conditions.

## Sophisticated Design

With classy semi flat front panel in chic white, the new series fit in various kinds of rooms and create relaxing atmosphere. Choice of wall hanging, floor standing or behind gallery installation is available.

## Quiet Operation

Thanks to optimum balance of air outlet direction and sufficient air flow volume, the sound level has been minimized. The level of SRF25ZIX-S in the cooling lo mode is 26dB(A) only.



## Auto air outlet selection

### Heating operation:

In case both lower and upper outlets operation with Auto fan speed mode is selected, the lower outlet will be kept for twenty minutes after the start or until room temperature is close to reaching the setting point. And then the air outlet will change to both outlets. That state will be maintained until the switch is turned off.

Automatic adjustment of lower air outlet direction prevents stirring up of warm air and keeps optimum comfort at floor level.



### Cooling operation:

In case both lower and upper outlets operation is selected in Cooling or Dry operation, both outlets will be kept for sixty minutes after the start or until room temperature is below the setting point. And then the air outlet will change to the upper outlet. That state will be maintained until switch is turned off.

In case both outlets operation with Auto fan speed mode is selected, the upper outlet will be kept for ten minutes after the start or until room temperature is close to reaching the setting point. And then the air outlet will change to both outlets in order to spread comfort air to every corner.



## Installation workability

Piping and drain hose connection can be selected out of 6-directions.

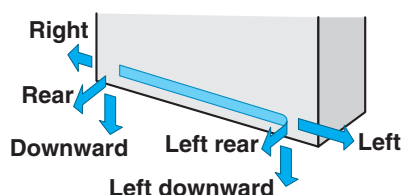

## Convenient to use operation

Besides on/off operation, simultaneous lower and upper air outlets or upper outlet can be selected by air flow direction button. Further control can be arranged by a remote control.

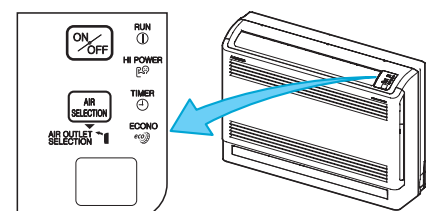

# INVERTER HEAT PUMP MODEL (High COP)

# SRR-ZJ

Ceiling Concealed type



Standard equipment

**NEW** SRR25ZJ-S, SRR35ZJ-S



SRR25/35ZJ can be selected for use as indoor units in the combination with SCM Multi system outdoor unit.

## Refrigerant pipe length

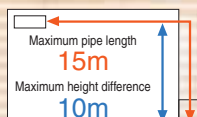

SRR25ZJ-S  
SRR35ZJ-S



SRC25ZJX-S, SRC35ZJX-S

## OPTIONAL PARTS FOR DUCTED TYPE



## FUNCTION



### Comfortable Functions



### Convenient & Economy Functions



### Maintenance & Prevention Functions



### Others



## SPECIFICATIONS

Model (Indoor unit/Outdoor unit)			SRR25ZJ-S SRC25ZJX-S	SRR35ZJ-S SRC35ZJX-S
Power supply			1Phase, 220/230/240V, 50Hz	
Cooling capacity	ISO-T1(JIS)	kW	2.5(0.9~3.2)	3.5(0.9~4.1)
Heating capacity	ISO-T1(JIS)	kW	3.4(0.9~4.7)	4.2(0.9~5.1)
Cooling input	at 230V	kW	0.58(0.19~0.82)	1.08(0.19~1.26)
Heating input	at 230V	kW	0.75(0.23~1.20)	1.10(0.23~1.43)
Cooling energy label			A	
Heating energy label			A	
EER (In cooling)			4.31	3.24
COP (In heating)			4.53	3.82
Running current	Cooling	A	2.9/2.8/2.7	5.0/4.7/4.5
	Heating	A	3.7/3.6/3.4	5.1/4.8/4.6
Sound power level *	Cooling(Indoor/Outdoor)	dB(A)	54/60	56/62
	Heating(Indoor/Outdoor)	dB(A)	55/60	57/62
Sound pressure level *	Cooling(Indoor)	dB(A)	Hi:40 Me:35 Lo:29	Hi:42 Me:37 Lo:30
	Heating(Indoor)	dB(A)	Hi:41 Me:38 Lo:31	Hi:43 Me:40 Lo:32
Air flow	Indoor	Cooling	Hi:8.5 Me:7.0 Lo:5.0	Hi:9.0 Me:7.5 Lo:5.5
		Heating	Hi:10.0 Me:9.0 Lo:6.5	Hi:11.0 Me:9.5 Lo:7.0
	Outdoor		Cooling:29.5 Heating:27.0	Cooling:32.5 Heating:29.5
Exterior dimensions (H×W×D)	Indoor	mm	230×740×455	
	Outdoor	mm	595×780(+62)×290	
Net weight	Indoor/Outdoor	kg	22/38	
Refrigerant piping	O.D	Liquid line	φ 6.35 (1/4")	
		Gas line	φ 9.52 (3/8")	
	Connecting method		Flare connecting	
Refrigerant			R410A	
Clean filter			—	

The data are measured under the following conditions(ISO-T1). Cooling: Indoor temp. of 27°CDB, 19°CWB, and outdoor temp. of 35°CDB. Heating: Indoor temp. of 20°CDB, and outdoor temp. of 7°CDB, 6°CWB.

\* Indicates the value in anechoic chamber. During operation these values are somewhat higher due to ambient conditions.

# INVERTER HEAT PUMP MODEL (High COP)

# FDTC-VD

4way ceiling cassette type



FDTC25VD  
FDTC35VD  
FDTC40VD  
FDTC50VD



Fits into standard  
600 x 600 ceiling

**NEW**

FDTC25VD, FDTC35VD,  
FDTC40VD, FDTC50VD,  
FDTC60VD

## Individual flap control system

According to room temperature conditions, four directions of air flow can be controlled by individual flap as preferred. As individual flap control is available even after installation, installation area became wider than before.



## Flap control system

Selection of louver position is possible. Louvers can be set at different angles.

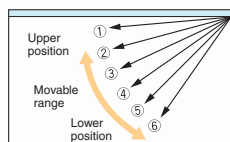

## 600mm Drain Pump is mounted

Drain can be discharged upward by 600mm from the ceiling surface close to the indoor unit. It allows a piping layout with a high degree of freedom depending on the installation location.

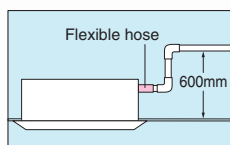

All FDTC-VD series (except FDTC40VD) can be selected for use as indoor units in the combination with SCM Multi system outdoor unit.

Wired remote control



RC-E4(option) RCH-E3(option)

Wireless remote control



RCN-TC-24W-ER(option)



SRC25ZJX-S, SRC35ZJX-S



SRC40ZIX-S, SRC50ZIX-S,  
SRC60ZIX-S

Refrigerant pipe length

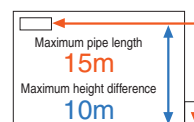

FDTC25VD, FDTC35VD

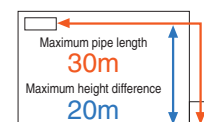

FDTC40VD, FDTC50VD  
FDTC60VD

## FUNCTION

Comfortable Functions



Comfortable Air Flow Functions



Convenient & Economy Functions



Maintenance & Prevention Functions



Others



## SPECIFICATIONS

Model (Indoor unit/Outdoor unit)			FDTC25VD SRC25ZJX-S	FDTC35VD SRC35ZJX-S	FDTC40VD SRC40ZIX-S	FDTC50VD SRC50ZIX-S	FDTC60VD SRC60ZIX-S
Power supply			1Phase, 220/230/240V, 50Hz				
Cooling capacity	ISO-T1(JIS)	kW	2.55(0.9~3.2)	3.6(0.9~4.1)	4.0(1.8~4.7)	5.0(2.2~5.6)	5.6(2.8~6.3)
Heating capacity	ISO-T1(JIS)	kW	3.45(0.9~4.7)	4.25(0.9~5.1)	4.5(2.0~5.4)	5.4(2.5~6.3)	6.7(3.1~6.7)
Cooling input	at 230V	kW	0.6	1.07	1.04	1.56	1.99
Heating input	at 230V	kW	0.84	1.16	1.10	1.45	2.08
Cooling energy label			A				
Heating energy label			A				
EER (In cooling)			4.25	3.36	3.85	3.21	2.81
COP (In heating)			4.11	3.66	4.09	3.73	3.22
Running current	Cooling	A	3.0/2.9/2.8	4.9/4.7/4.5	4.6	6.9	8.3
	Heating	A	4.1/4.0/3.8	5.3/5.1/4.9	4.9	6.4	8.7
Sound pressure level * ※	Cooling(Indoor)	dB(A)	Hi:36 Me:32 Lo:29	Hi:40 Me:36 Lo:30	Hi:42 Me:36 Lo:30	Hi:42 Me:36 Lo:30	Hi:46 Me:39 Lo:30
			Hi:38 Me:33 Lo:29.5	Hi:42 Me:35 Lo:32	Hi:42 Me:36 Lo:32	Hi:46 Me:39 Lo:32	
	Heating(Indoor)	dB(A)	Hi:9 Me:8 Lo:6.5	Hi:9.5 Me:9 Lo:7	Hi:18 Me:16 Lo:14		
Air flow	Indoor	CMM	Hi:9.5 Me:8.5 Lo:7	Hi:10 Me:9 Lo:8	Hi:18 Me:16 Lo:14		
			Cooling:29.5 Heating:27.0	Cooling:32.5 Heating:29.5	40		
Exterior dimensions (H×W×D)	Indoor	mm	Unit : 248×570×570 Panel : 35×700×700				
	Outdoor	mm	595×780(+62)×290		640×800(+71)×290		
Net weight	Indoor/Outdoor	kg	18.5 (Unit:15 Panel:3.5)/38			18.5 (Unit:15 Panel:3.5)/43	
Refrigerant piping	O.D	Liquid line	φ 6.35 (1/4")			φ 12.7 (1/2")	
		Gas line	φ 9.52 (3/8")			φ 12.7 (1/2")	
	Connecting method		Flare connecting				
Refrigerant			R410A				
Panel			TC-PSA-25W-E				

The data are measured under the following conditions(ISO-T1). Cooling: Indoor temp. of 27°CDB, 19°CWB, and outdoor temp. of 35°CDB. Heating: Indoor temp. of 20°CDB, and outdoor temp. of 7°CDB, 6°CWB.  
\* Indicates the value in an anechoic chamber. During operation these values are somewhat higher due to ambient conditions.

※ Powerful-Hi can be selected. Sound level:25VD(Cooling:38 Heating:39), 35VD(Cooling:41 Heating:43), 40/50/60VD(Cooling:47 Heating:47)

## INVERTER MULTI-SPLIT MODEL

# Inverter Multi-split System



The multi-split system allows a single outdoor unit to service a range of configurations of up to four indoor unit ---- from a lineup of 6 units ranging from 6.0kW to 13.5kW.



ZJX, ZJR, ZJ  
Wall mounted type **SRK**



Ceiling Concealed type **SRR**



4way ceiling cassette type **FDTC**



600 x 600  
Super Compact type



Floor type **SRF**

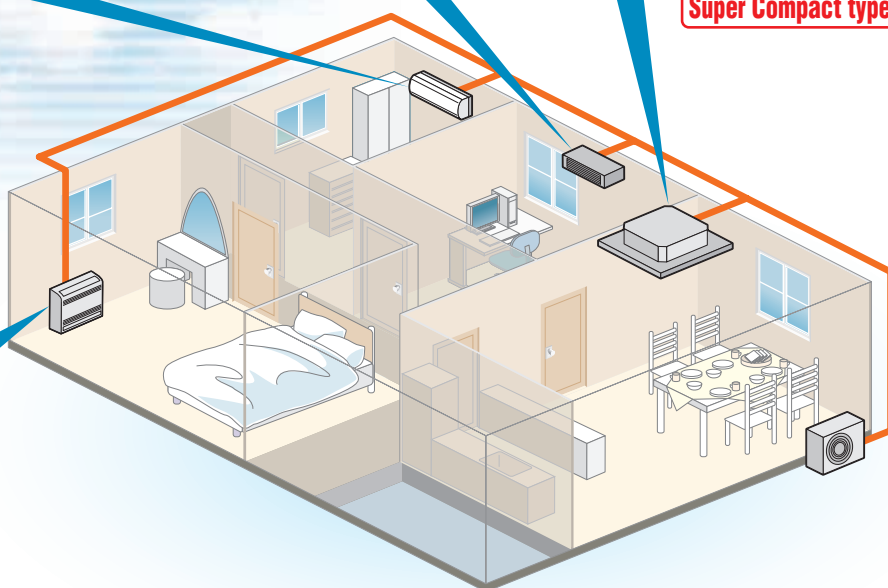
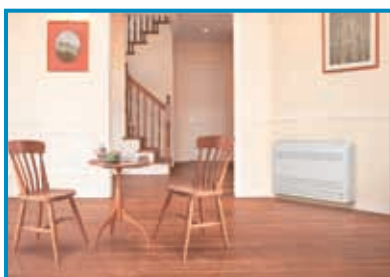

## OUTDOOR UNIT



SCM40ZJ-S, SCM45ZJ-S  
SCM50ZJ-S, SCM60ZJ-S



SCM71ZJ-S, SCM80ZJ-S

# The industry's highest COP levels

Our new models, SCM40~80ZJ-S have realized the highest level of COP (coefficient of performance) in the industry with full model change to both of outdoor and indoor (SRK series) units.

Outdoor unit uses new advanced compressors with new inverter control (Vector control) and new M shape fin.

Indoor units SRK series are the latest series, which are common to both of single and multi system, using the new heat exchanger and improved air flow system.

**EER in Cooling**

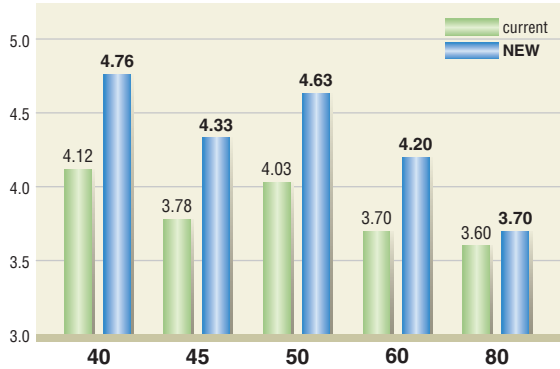

**COP in Heating**

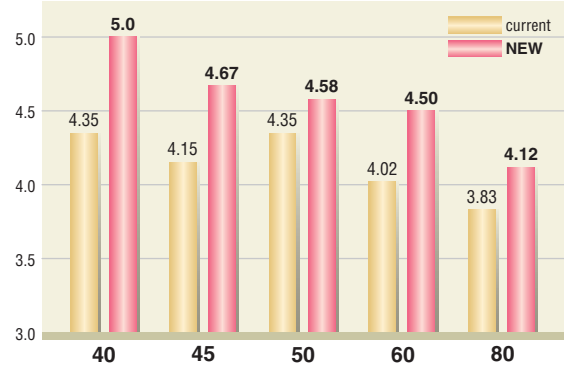

## PIPING LENGTH

**Limit** The maximum piping length of the refrigerant pipes for the outdoor units, and the maximum height difference for the outdoor units are as shown below.

	SCM40ZJ-S	SCM45ZJ-S	SCM50ZJ-S	SCM60ZJ-S	SCM71ZJ-S	SCM80ZJ-S
length for one indoor unit	under 25m	under 25m	under 25m	under 25m	under 25m	under 25m
total length for all rooms	under 30m	under 30m	under 40m	under 40m	under 70m	under 70m
height difference	lower installation spot of the indoor unit (A)	under 15m	under 15m	under 15m	under 15m	under 20m
	upper installation spot of the indoor unit (B)	under 15m	under 15m	under 15m	under 15m	under 20m
	maximum height difference of the indoor units (C)	under 25m	under 25m	under 25m	under 25m	under 25m
length of precharged refrigerant pipe	30m	30m	40m	40m	40m	40m

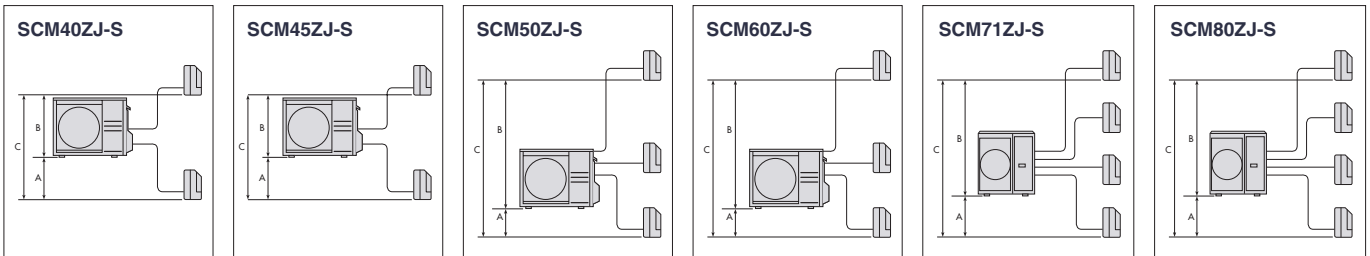

## OUTDOOR UNIT SPECIFICATIONS

Item	Model	For two rooms		For three rooms		For four rooms	
		SCM40ZJ-S	SCM45ZJ-S	SCM50ZJ-S	SCM60ZJ-S	SCM71ZJ-S	SCM80ZJ-S
Power supply		1Phase, 220/230/240V, 50Hz					
Cooling capacity	ISO-T1 kW	4.0(1.8~5.9)	4.5(1.8~6.4)	5.0(1.8~7.1)	6.0(1.8~7.5)	7.1(1.8~8.8)	8.0(1.8~9.2)
Heating capacity	ISO-T1 kW	4.5(1.4~6.9)	5.6(1.4~7.4)	6.0(1.4~7.5)	6.8(1.5~7.8)	8.6(1.5~9.4)	9.3(1.5~9.8)
COP (In cooling)		4.76	4.33	4.63	4.2	4.08	3.70
COP (In heating)		5.00	4.67	4.58	4.5	4.30	4.12
Energy label (In cooling)		A	A	A	A	A	A
Energy label (In heating)		A	A	A	A	A	A
Sound power level *	Cooling dB(A)	60	60	62	63	65	66
	Heating dB(A)	62	62	65	65	66	66
Sound pressure level *	Cooling dB(A)	47	47	49	50	52	54
	Heating dB(A)	48	49	52	52	54	54
Air flow	Cooling CMM	40.0	40.0	41.0	42.0	56.0	56.0
	Heating CMM	40.0	40.0	41.0	42.0	56.0	56.0
Exterior dimensions (H×W×D)	mm	640×850(+65)×290				750×880(+73)×340	
Net weight	kg	47	47	48	49	62	
Compressor type		Twin rotary type×1					
Refrigerant		R410A					
Indoor units to be combined		20, 25, 35		20, 25, 35, 50		20, 25, 35, 50, 60	
Total of indoor units	class kW	6.0	7.0	8.5	11.0	12.5	13.5

The data are measured under the following conditions(ISO-T1). Cooling: Indoor temp. of 27°CDB, 19°CWB, and outdoor temp. of 35°CDB. Heating: Indoor temp. of 20°CDB, and outdoor temp. of 7°CDB, 6°CWB. \* Indicates the value in an anechoic chamber. During operation these values are somewhat higher due to ambient conditions.

## Multi System INDOOR UNIT



# SRK-ZJX

Wall mounted type



### FUNCTION



### Comfortable Air Flow Functions



### Convenient & Economy Functions



### Maintenance & Prevention Functions



### Others



### SPECIFICATIONS

Item	Model	SRK20ZJX-S	SRK25ZJX-S	SRK35ZJX-S	SRK50ZJX-S	SRK60ZJX-S	
Cooling capacity	ISO-T1(JIS) kW	2.0	2.5	3.5	5.0	6.0	
Heating capacity	ISO-T1(JIS) kW	3.0	3.4	4.5	5.8	6.8	
Sound power level *	Cooling dB(A)	53	55	58	60	62	
	Heating dB(A)	54	58	59	62	62	
Sound pressure level *	Cooling dB(A)	Hi:39 Me:30 Lo:21	Hi:41 Me:31 Lo:22	Hi:43 Me:33 Lo:22	Hi:45 Me:38 Lo:26	Hi:47 Me:38 Lo:26	
	Heating dB(A)	Hi:38 Me:33 Lo:25	Hi:41 Me:34 Lo:27	Hi:42 Me:35 Lo:27	Hi:45 Me:38 Lo:32	Hi:45 Me:39 Lo:33	
Air flow	Indoor	Cooling	Hi:11.5 Me:8.0 Lo:5.0	Hi:12.5 Me:9.0 Lo:5.0	Hi:13.5 Me:9.5 Lo:5.0	Hi:13.5 Me:11.0 Lo:8.0	Hi:14.5 Me:12.5 Lo:8.5
		Heating	Hi:12.0 Me:9.5 Lo:7.5	Hi:13.0 Me:10.0 Lo:7.5	Hi:14.0 Me:11.0 Lo:8.0	Hi:16.5 Me:14.5 Lo:10.5	Hi:17.0 Me:15.0 Lo:11.0
Exterior dimensions (H×W×D)	mm	309×890×220					
Net weight	kg	15					
Clean filter		Allergen Clear Filter × 1, Photocatalytic Washable Deodorizing Filter × 1					
Piping	Liquid line	mm(in)	φ 6.35(1/4")			φ 12.7(1/2")	
	Gas line	mm(in)	φ 9.52(3/8")				
OUTDOOR UNITS TO BE COMBINED		SCM40,45,50,60,71,80ZJ-S			SCM50,60,71,80ZJ-S	SCM60,71,80ZJ-S	

The data are measured under the following conditions(ISO-T1). Cooling: Indoor temp. of 27°CDB, 19°CWB, and outdoor temp. of 35°CDB. Heating: Indoor temp. of 20°CDB, and outdoor temp. of 7°CDB, 6°CWB.  
\* Indicates the value in an anechoic chamber. During operation these values are somewhat higher due to ambient conditions.



# SRK-ZJR

Wall mounted type



### FUNCTION



### Comfortable Air Flow Functions



### Convenient & Economy Functions



### Maintenance & Prevention Functions



### Others



### SPECIFICATIONS

Item	Model	SRK25ZJR-S	SRK35ZJR-S
Cooling capacity	ISO-T1(JIS) kW	2.5	3.5
Heating capacity	ISO-T1(JIS) kW	3.4	4.5
Sound power level *	Cooling dB(A)	49	57
	Heating dB(A)	55	58
Sound pressure level *	Cooling dB(A)	Hi:34 Me:28 Lo:21	Hi:41 Me:32 Lo:22
	Heating dB(A)	Hi:39 Me:31 Lo:24	Hi:42 Me:37 Lo:25
Air flow	Indoor	Cooling	Hi:7.9 Me:6.0 Lo:5.0
		Heating	Hi:11.0 Me:6.5 Lo:5.1
Exterior dimensions (H×W×D)	mm	294×798×229	
Net weight	kg	9.5	
Clean filter		Allergen Clear Filter × 1, Photocatalytic Washable Deodorizing Filter × 1	
Piping	Liquid line	mm(in)	φ 6.35(1/4")
	Gas line	mm(in)	φ 9.52(3/8")
OUTDOOR UNITS TO BE COMBINED		SCM40, 45, 50, 60, 71, 80ZJ-S	

The data are measured under the following conditions(ISO-T1). Cooling: Indoor temp. of 27°CDB, 19°CWB, and outdoor temp. of 35°CDB. Heating: Indoor temp. of 20°CDB, and outdoor temp. of 7°CDB, 6°CWB.  
\* Indicates the value in an anechoic chamber. During operation these values are somewhat higher due to ambient conditions.



# SRK-ZJ

Wall mounted type



## FUNCTION



### Comfortable Air Flow Functions



### Convenient & Economy Functions



### Maintenance & Prevention Functions



### Others



## SPECIFICATIONS

Item	Model	SRK20ZJ-S	SRK25ZJ-S	SRK35ZJ-S	SRK50ZJ-S	
Cooling capacity	ISO-T1(JIS) kW	2.0	2.5	3.5	5.0	
Heating capacity	ISO-T1(JIS) kW	3.0	3.4	4.5	5.8	
Sound power level *	Cooling dB(A)	49	50	58	61	
	Heating dB(A)	52	55	59	61	
Sound pressure level *	Cooling dB(A)	Hi:33 Me:27 Lo:21	Hi:34 Me:28 Lo:21	Hi:42 Me:32 Lo:22	Hi:46 Me:37 Lo:26	
	Heating dB(A)	Hi:36 Me:31 Lo:24	Hi:39 Me:31 Lo:24	Hi:43 Me:37 Lo:25	Hi:45 Me:37 Lo:31	
Air flow	Indoor	Cooling	Hi:7.8 Me:5.6 Lo:4.8	Hi:7.9 Me:6.0 Lo:5.0	Hi:10.1 Me:6.4 Lo:5.0	Hi:11.3 Me:7.8 Lo:5.3
		Heating	Hi:9.8 Me:6.3 Lo:5.0	Hi:10.6 Me:6.5 Lo:5.1	Hi:12.8 Me:9.4 Lo:6.1	Hi:13.5 Me:10.2 Lo:7.5
Exterior dimensions (H×W×D)	mm	294×798×229				
Net weight	kg	9.5				
Clean filter		Allergen Clear Filter × 1, Photocatalytic Washable Deodorizing Filter × 1				
Piping	Liquid line	mm(in)	φ 6.35(1/4")			
	Gas line	mm(in)	φ 9.52(3/8")		φ 12.7(1/2")	
OUTDOOR UNITS TO BE COMBINED		SCM40,45,50,60,71,80ZJ-S			SCM50,60,71,80ZJ-S	

The data are measured under the following conditions(ISO-T1). Cooling: Indoor temp. of 27°CDB, 19°CWB, and outdoor temp. of 35°CDB. Heating: Indoor temp. of 20°CDB, and outdoor temp. of 7°CDB, 6°CWB. \* Indicates the value in an anechoic chamber. During operation these values are somewhat higher due to ambient conditions.

# SRF-ZJX

Floor type



## FUNCTION



### Convenient & Economy Functions



### Maintenance & Prevention Functions



### Others



## SPECIFICATIONS

Item	Model	SRF25ZJX-S	SRF35ZJX-S	SRF50ZJX-S	
Cooling capacity	ISO-T1(JIS) kW	2.5	3.5	5.0	
Heating capacity	ISO-T1(JIS) kW	3.4	4.5	5.8	
Sound power level *	Cooling dB(A)	51	52	58	
	Heating dB(A)	51	52	58	
Sound pressure level *	Cooling dB(A)	Hi:40 Me:32 Lo:26	Hi:41 Me:34 Lo:28	Hi:47 Me:39 Lo:30	
	Heating dB(A)	Hi:40 Me:35 Lo:28	Hi:41 Me:36 Lo:31	Hi:47 Me:39 Lo:32	
Air flow	Indoor	Cooling	Hi:9.0 Me:7.6 Lo:5.8	Hi:9.2 Me:7.8 Lo:6.4	Hi:11.5 Me:9.6 Lo:6.6
		Heating	Hi:10.5 Me:8.2 Lo:6.6	Hi:10.7 Me:8.3 Lo:7.4	Hi:12.0 Me:10.0 Lo:7.6
Exterior dimensions (H×W×D)	mm	600×860×238			
Net weight	kg	18	19		
Clean filter		Natural Enzyme FilterX1 Photocatalytic Washable Deodorizing FilterX1			
Piping	Liquid line	mm(in)	φ 6.35(1/4")		
	Gas line	mm(in)	φ 9.52(3/8")		
OUTDOOR UNITS TO BE COMBINED		SCM40,45,50,60,71,80ZJ-S			

The data are measured under the following conditions(ISO-T1). Cooling: Indoor temp. of 27°CDB, 19°CWB, and outdoor temp. of 35°CDB. Heating: Indoor temp. of 20°CDB, and outdoor temp. of 7°CDB, 6°CWB. \* Indicates the value in an anechoic chamber. During operation these values are somewhat higher due to ambient conditions.

# INVERTER MULTI-SPLIT SYSTEM

## SRR-ZJ

Ceiling Concealed type



### FUNCTION



### OPTIONAL PARTS FOR DUCTED TYPE



### SPECIFICATIONS

Item	Model	SRR25ZJ-S	SRR35ZJ-S	SRR50ZJ-S	SRR60ZJ-S
Cooling capacity	ISO-T1(JIS) kW	2.5	3.5	5.0	6.0
Heating capacity	ISO-T1(JIS) kW	3.4	4.5	5.8	6.8
Sound power level *	Cooling dB(A)	54	56	60	63
	Heating dB(A)	55	57	60	63
Sound pressure level *	Cooling dB(A)	Hi:40 Me:35 Lo:29	Hi:42 Me:37 Lo:30	Hi:48 Me:42 Lo:33	Hi:51 Me:44 Lo:35
	Heating dB(A)	Hi:41 Me:38 Lo:31	Hi:43 Me:40 Lo:32	Hi:48 Me:45 Lo:36	Hi:51 Me:47 Lo:38
Air flow Q'ty (Hi)	Cooling CMM	8.5	9.0	10.5	12.5
	Heating CMM	10.0	11.0	13.0	15.0
Exterior dimensions(H×W×D)	mm	230×740×455			
Net weight	kg	22		23	
Piping	Liquid line mm(in)	φ 6.35(1/4")		φ 6.35(1/4")	
	Gas line mm(in)	φ 9.52(3/8")		φ 12.7(1/2")	
OUTDOOR UNITS TO BE COMBINED		SCM40,45,50,60,71,80ZJ-S		SCM50,60,71,80ZJ-S	SCM60,71,80ZJ-S

The data are measured under the following conditions(ISO-T1). Cooling: Indoor temp. of 27°CDB, 19°CWB, and outdoor temp. of 35°CDB. Heating: Indoor temp. of 20°CDB, and outdoor temp. of 7°CDB, 6°CWB.  
\* Indicates the value in anechoic chamber. During operation these values are somewhat higher due to ambient conditions.

## FDTC-VD

4way ceiling cassette type

600×600  
Super Compact type

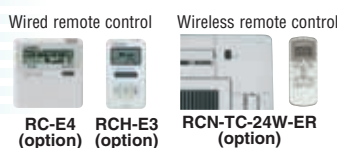

### FUNCTION



### SPECIFICATIONS

Item	Model	FDTC25VD	FDTC35VD	FDTC50VD	FDTC60VD
Cooling capacity	ISO-T1(JIS) kW	2.5	3.5	5.0	6.0
Heating capacity	ISO-T1(JIS) kW	3.4	4.5	5.8	6.8
Sound pressure level *	Cooling dB(A)	Hi:36 Me:32 Lo:29	Hi:40 Me:36 Lo:30	Hi:42 Me:36 Lo:30	Hi:46 Me:39 Lo:30
	Heating dB(A)	Hi:38 Me:33 Lo:29.5	Hi:42 Me:35 Lo:32	Hi:42 Me:36 Lo:32	Hi:46 Me:39 Lo:32
Air flow Q'ty (Hi)	Cooling CMM	9	9.5	11.5	13.5
	Heating CMM	9.5	10.0	11.5	13.5
Exterior dimensions (H×W×D)	Main unit mm	248×570×570			
	Panel mm	35×700×700			
Net weight	Main unit kg	15			
	Panel kg	3.5			
Piping	Liquid line mm(in)	φ 6.35(1/4")		φ 6.35(1/4")	
	Gas line mm(in)	φ 9.52(3/8")		φ 12.7(1/2")	
OUTDOOR UNITS TO BE COMBINED		SCM40,45,50,60,71,80ZJ-S		SCM50,60,71,80ZJ-S	SCM60,71,80ZJ-S

The data are measured under the following conditions(ISO-T1). Cooling: Indoor temp. of 27°CDB, 19°CWB, and outdoor temp. of 35°CDB. Heating: Indoor temp. of 20°CDB, and outdoor temp. of 7°CDB, 6°CWB.  
\* Indicates the value in anechoic chamber. During operation these values are somewhat higher due to ambient conditions.

※ Powerful-Hi can be selected. Sound level:25VD(Cooling:38 Heating:39), 35VD(Cooling:41 Heating:43), 40/50/60VD(Cooling:47 Heating:47)

## Number of connectable indoor units

	SCM40ZJ-S	SCM45ZJ-S	SCM50ZJ-S	SCM60ZJ-S	SCM71ZJ-S	SCM80ZJ-S
MIN	2	2	2	2	2	2
MAX	2	2	3	3	4	4

## Combinations

Table of Indoor unit combination SCM40ZJ-S  
<with all indoor unit SRK-ZJX-S type only>  
(Heating operation)

Indoor unit combination	Heating capacity (kW)						Power consumption (W)			Standard current (A)		
	Room heating capacity (kW)		Total capacity (kW)			Min.	Standard	Max.	220V	230V	240V	
	A room	B room	Min.	Standard	Max.							
1 room	20	3.0	—	1.4	3.0	3.7	470	750	1070	3.4	3.3	3.2
	25	3.4	—	1.4	3.4	4.2	470	920	1210	4.2	4.0	3.9
	35	4.5	—	1.4	4.5	5.0	470	1210	1450	5.6	5.3	5.1
2 room	20 + 20	2.25	2.25	2.0	4.5	6.9	530	900	2300	4.1	4.0	3.8
	20 + 25	2.49	3.11	2.0	5.6	6.9	530	1200	2300	5.5	5.3	5.1
	20 + 35	2.11	3.69	2.0	5.8	6.9	530	1290	2300	5.9	5.7	5.4
	25 + 25	2.90	2.90	2.0	5.8	6.9	530	1290	2300	5.9	5.7	5.4
	25 + 35	2.42	3.38	2.0	5.8	6.9	530	1290	2300	5.9	5.7	5.4

(Cooling operation)

Indoor unit combination	Cooling capacity (kW)						Power consumption (W)			Standard current (A)		
	Room cooling capacity (kW)		Total capacity (kW)			Min.	Standard	Max.	220V	230V	240V	
	A room	B room	Min.	Standard	Max.							
1 room	20	2.0	—	1.8	2.0	2.8	490	530	880	2.4	2.3	2.2
	25	2.5	—	1.8	2.5	3.4	490	670	1040	3.1	2.9	2.8
	35	3.5	—	1.8	3.5	3.9	490	970	1200	4.5	4.3	4.1
2 room	20 + 20	2.00	2.00	3.0	4.0	5.7	560	840	1750	3.9	3.7	3.5
	20 + 25	2.00	2.50	3.0	4.5	5.9	560	1040	1900	4.8	4.6	4.4
	20 + 35	1.89	3.31	3.0	5.2	5.9	560	1430	1900	6.6	6.3	6.0
	25 + 25	2.50	2.50	3.0	5.0	5.9	560	1280	1900	5.9	5.6	5.4
	25 + 35	2.17	3.03	3.0	5.2	5.9	560	1430	1900	6.6	6.3	6.0

Table of Indoor unit combination SCM40ZJ-S  
<with indoor unit except all indoor unit SRK-ZJX-S type only>  
(Heating operation)

Indoor unit combination	Heating capacity (kW)						Power consumption (W)			Standard current (A)		
	Room heating capacity (kW)		Total capacity (kW)			Min.	Standard	Max.	220V	230V	240V	
	A room	B room	Min.	Standard	Max.							
1 room	20	3.0	—	1.4	3.0	3.5	470	900	1070	4.1	4.0	3.8
	25	3.4	—	1.4	3.4	4.0	470	1070	1210	4.9	4.7	4.5
	35	4.5	—	1.4	4.5	4.8	470	1340	1450	6.2	5.9	5.6
2 room	20 + 20	2.25	2.25	2.0	4.5	6.7	530	930	2300	4.3	4.1	3.9
	20 + 25	2.49	3.11	2.0	5.6	6.7	530	1240	2300	5.7	5.4	5.2
	20 + 35	2.11	3.69	2.0	5.8	6.7	530	1330	2300	6.1	5.8	5.6
	25 + 25	2.90	2.90	2.0	5.8	6.7	530	1330	2300	6.1	5.8	5.6
	25 + 35	2.42	3.38	2.0	5.8	6.7	530	1330	2300	6.1	5.8	5.6

(Cooling operation)

Indoor unit combination	Cooling capacity (kW)						Power consumption (W)			Standard current (A)		
	Room cooling capacity (kW)		Total capacity (kW)			Min.	Standard	Max.	220V	230V	240V	
	A room	B room	Min.	Standard	Max.							
1 room	20	2.0	—	1.8	2.0	2.7	490	560	880	2.6	2.5	2.4
	25	2.5	—	1.8	2.5	3.2	490	710	1040	3.3	3.1	3.0
	35	3.5	—	1.8	3.5	3.7	490	1030	1200	4.7	4.5	4.3
2 room	20 + 20	2.00	2.00	3.0	4.0	5.6	560	880	1750	4.0	3.9	3.7
	20 + 25	2.00	2.50	3.0	4.5	5.8	560	1090	1900	5.0	4.8	4.6
	20 + 35	1.89	3.31	3.0	5.2	5.8	560	1500	1900	6.9	6.6	6.3
	25 + 25	2.50	2.50	3.0	5.0	5.8	560	1340	1900	6.2	5.9	5.6
	25 + 35	2.17	3.03	3.0	5.2	5.8	560	1500	1900	6.9	6.6	6.3

Table of Indoor unit combination SCM45ZJ-S  
<with all indoor unit SRK-ZJX-S type only>  
(Heating operation)

Indoor unit combination	Heating capacity (kW)						Power consumption (W)			Standard current (A)		
	Room heating capacity (kW)		Total capacity (kW)			Min.	Standard	Max.	220V	230V	240V	
	A room	B room	Min.	Standard	Max.							
1 room	20	3.0	—	1.4	3.0	3.7	470	750	1070	3.4	3.3	3.2
	25	3.4	—	1.4	3.4	4.2	470	920	1210	4.2	4.0	3.9
	35	4.5	—	1.4	4.5	5.0	470	1210	1450	5.6	5.3	5.1
2 room	20 + 20	2.25	2.25	2.0	4.5	7.4	530	900	2570	4.1	4.0	3.8
	20 + 25	2.49	3.11	2.0	5.6	7.4	530	1200	2570	5.5	5.3	5.1
	20 + 35	2.36	4.14	2.0	6.5	7.4	530	1500	2570	6.9	6.6	6.3
	25 + 25	3.25	3.25	2.0	6.5	7.4	530	1500	2570	6.9	6.6	6.3
	25 + 35	2.71	3.79	2.0	6.5	7.4	530	1500	2570	6.9	6.6	6.3
	35 + 35	3.25	3.25	2.0	6.5	7.4	530	1500	2570	6.9	6.6	6.3

# INVERTER MULTI-SPLIT SYSTEM

## (Cooling operation)

Indoor unit combination	Cooling capacity (kW)						Power consumption (W)			Standard current (A)		
	Room cooling capacity (kW)		Total capacity (kW)			Min.	Standard	Max.	220V	230V	240V	
	A room	B room	Min.	Standard	Max.							
1 room	20	2.0	—	1.8	2.0	2.8	490	530	880	2.4	2.3	2.2
	25	2.5	—	1.8	2.5	3.4	490	670	1040	3.1	2.9	2.8
	35	3.5	—	1.8	3.5	3.9	490	970	1200	4.5	4.3	4.1
2 room	20 + 20	2.00	2.00	3.0	4.0	5.7	560	840	1750	3.9	3.7	3.5
	20 + 25	2.00	2.50	3.0	4.5	5.9	560	1040	1900	4.8	4.6	4.4
	20 + 35	2.00	3.50	3.0	5.5	6.3	560	1490	2110	6.8	6.5	6.3
	25 + 25	2.50	2.50	3.0	5.0	6.2	560	1280	2050	5.9	5.6	5.4
	25 + 35	2.42	3.38	3.0	5.8	6.4	560	1740	2140	8.0	7.6	7.3
35 + 35	2.90	2.90	3.0	5.8	6.4	560	1740	2140	8.0	7.6	7.3	

**Table of Indoor unit combination SCM45ZJ-S**  
 <with indoor unit except all indoor unit SRK-ZJX-S type only>  
 (Heating operation)

Indoor unit combination	Heating capacity (kW)						Power consumption (W)			Standard current (A)		
	Room heating capacity (kW)		Total capacity (kW)			Min.	Standard	Max.	220V	230V	240V	
	A room	B room	Min.	Standard	Max.							
1 room	20	3.0	—	1.4	3.0	3.5	470	900	1070	4.1	4.0	3.8
	25	3.4	—	1.4	3.4	4.0	470	1070	1210	4.9	4.7	4.5
	35	4.5	—	1.4	4.5	4.8	470	1340	1450	6.2	5.9	5.6
2 room	20 + 20	2.25	2.25	2.0	4.5	7.2	530	930	2570	4.3	4.1	3.9
	20 + 25	2.49	3.11	2.0	5.6	7.2	530	1240	2570	5.7	5.4	5.2
	20 + 35	2.36	4.14	2.0	6.5	7.2	530	1550	2570	7.1	6.8	6.5
	25 + 25	3.25	3.25	2.0	6.5	7.2	530	1550	2570	7.1	6.8	6.5
	25 + 35	2.71	3.79	2.0	6.5	7.2	530	1550	2570	7.1	6.8	6.5
35 + 35	3.25	3.25	2.0	6.5	7.2	530	1550	2570	7.1	6.8	6.5	

## (Cooling operation)

Indoor unit combination	Cooling capacity (kW)						Power consumption (W)			Standard current (A)		
	Room cooling capacity (kW)		Total capacity (kW)			Min.	Standard	Max.	220V	230V	240V	
	A room	B room	Min.	Standard	Max.							
1 room	20	2.0	—	1.8	2.0	2.7	490	560	880	2.6	2.5	2.4
	25	2.5	—	1.8	2.5	3.2	490	710	1040	3.3	3.1	3.0
	35	3.5	—	1.8	3.5	3.7	490	1030	1200	4.7	4.5	4.3
2 room	20 + 20	2.00	2.00	3.0	4.0	5.6	560	880	1750	4.0	3.9	3.7
	20 + 25	2.00	2.50	3.0	4.5	5.8	560	1090	1900	5.0	4.8	4.6
	20 + 35	2.00	3.50	3.0	5.5	6.2	560	1560	2110	7.2	6.9	6.6
	25 + 25	2.50	2.50	3.0	5.0	6.1	560	1340	2050	6.2	5.9	5.6
	25 + 35	2.42	3.38	3.0	5.8	6.3	560	1820	2140	8.4	8.0	7.7
35 + 35	2.90	2.90	3.0	5.8	6.3	560	1820	2140	8.4	8.0	7.7	

**Table of Indoor unit combination SCM50ZJ-S**  
 <with all indoor unit SRK-ZJX-S type only>  
 (Heating operation)

Indoor unit combination	Heating capacity (kW)						Power consumption (W)			Standard current (A)			
	Room heating capacity (kW)			Total capacity (kW)			Min.	Standard	Max.	220V	230V	240V	
	A room	B room	C room	Min.	Standard	Max.							
1 room	20	3.0	—	—	1.4	3.0	3.7	480	820	1100	3.8	3.6	3.5
	25	3.4	—	—	1.4	3.4	4.2	480	980	1240	4.5	4.3	4.1
	35	4.5	—	—	1.4	4.5	5.0	480	1280	1490	5.9	5.6	5.4
	50	5.8	—	—	1.4	5.8	6.2	480	1740	2260	8.0	7.6	7.3
2 room	20 + 20	2.95	2.95	—	2.0	5.9	7.3	540	1480	2580	6.8	6.5	6.2
	20 + 25	2.67	3.33	—	2.0	6.0	7.3	540	1530	2580	7.0	6.7	6.4
	20 + 35	2.29	4.01	—	2.0	6.3	7.3	540	1620	2580	7.4	7.1	6.8
	20 + 50	1.89	4.71	—	2.0	6.6	7.3	540	1710	2580	7.9	7.5	7.2
	25 + 25	3.05	3.05	—	2.0	6.1	7.3	540	1560	2580	7.2	6.9	6.6
	25 + 35	2.67	3.73	—	2.0	6.4	7.3	540	1650	2580	7.6	7.2	6.9
	25 + 50	2.20	4.40	—	2.0	6.6	7.3	540	1710	2580	7.9	7.5	7.2
	35 + 35	3.30	3.30	—	2.0	6.6	7.3	540	1710	2580	7.9	7.5	7.2
35 + 50	2.72	3.88	—	2.0	6.6	7.3	540	1710	2580	7.9	7.5	7.2	
3 room	20 + 20 + 20	2.00	2.00	2.00	3.0	6.0	7.5	600	1310	2580	6.0	5.8	5.5
	20 + 20 + 25	1.91	1.91	2.38	3.0	6.2	7.5	600	1400	2580	6.4	6.1	5.9
	20 + 20 + 35	1.76	1.76	3.08	3.0	6.6	7.5	600	1560	2580	7.2	6.9	6.6
	20 + 25 + 25	1.83	2.29	2.29	3.0	6.4	7.5	600	1470	2580	6.7	6.5	6.2
	20 + 25 + 35	1.70	2.13	2.98	3.0	6.8	7.5	600	1620	2580	7.4	7.1	6.8
	25 + 25 + 25	2.20	2.20	2.20	3.0	6.6	7.5	600	1560	2580	7.2	6.9	6.6
25 + 25 + 35	2.06	2.06	2.88	3.0	7.0	7.5	600	1690	2580	7.8	7.4	7.1	

## (Cooling operation)

Indoor unit combination	Cooling capacity (kW)						Power consumption (W)			Standard current (A)			
	Room Cooling capacity (kW)			Total capacity (kW)			Min.	Standard	Max.	220V	230V	240V	
	A room	B room	C room	Min.	Standard	Max.							
1 room	20	2.0	—	—	1.8	2.0	2.8	500	550	900	2.5	2.4	2.3
	25	2.5	—	—	1.8	2.5	3.4	500	720	1070	3.3	3.2	3.0
	35	3.5	—	—	1.8	3.5	3.9	500	1080	1230	5.0	4.7	4.5
	50	5.0	—	—	1.8	5.0	5.5	500	1700	2000	7.8	7.5	7.2

## (Cooling operation)

Indoor unit combination	Cooling capacity (kW)						Power consumption (W)			Standard current (A)			
	Room Cooling capacity (kW)			Total capacity (kW)			Min.	Standard	Max.	220V	230V	240V	
	A room	B room	C room	Min.	Standard	Max.							
2 room	20 + 20	2.00	2.00	—	3.0	4.0	5.7	570	910	1800	4.2	4.0	3.8
	20 + 25	1.91	2.39	—	3.0	4.3	5.9	570	1070	1980	4.9	4.7	4.5
	20 + 35	1.82	3.18	—	3.0	5.0	6.2	570	1430	2070	6.6	6.3	6.0
	20 + 50	1.71	4.29	—	3.0	6.0	6.5	570	1960	2150	9.0	8.6	8.2
	25 + 25	2.35	2.35	—	3.0	4.7	6.2	570	1270	2070	5.8	5.6	5.3
	25 + 35	2.21	3.09	—	3.0	5.3	6.5	570	1600	2150	7.3	7.0	6.7
	25 + 50	2.00	4.00	—	3.0	6.0	6.5	570	1960	2150	9.0	8.6	8.2
	35 + 35	3.00	3.00	—	3.0	6.0	6.5	570	1960	2150	9.0	8.6	8.2
3 room	20 + 20 + 20	1.67	1.67	1.67	3.4	5.0	7.1	690	1080	2150	5.0	4.7	4.5
	20 + 20 + 25	1.60	1.60	2.00	3.4	5.2	7.1	690	1160	2150	5.3	5.1	4.9
	20 + 20 + 35	1.49	1.49	2.61	3.4	5.6	7.1	690	1330	2150	6.1	5.8	5.6
	20 + 25 + 25	1.54	1.93	1.93	3.4	5.4	7.1	690	1260	2150	5.8	5.5	5.3
	20 + 25 + 35	1.45	1.81	2.54	3.4	5.8	7.1	690	1430	2150	6.6	6.3	6.0
	25 + 25 + 25	1.87	1.87	1.87	3.4	5.6	7.1	690	1330	2150	6.1	5.8	5.6
	25 + 25 + 35	1.76	1.76	2.47	3.4	6.0	7.1	690	1490	2150	6.8	6.5	6.3

## Table of Indoor unit combination SCM50ZJ-S <with indoor unit except all indoor unit SRK-ZJX-S type only> (Heating operation)

Indoor unit combination	Heating capacity (kW)						Power consumption (W)			Standard current (A)			
	Room heating capacity (kW)			Total capacity (kW)			Min.	Standard	Max.	220V	230V	240V	
	A room	B room	C room	Min.	Standard	Max.							
1 room	20	3.0	—	—	1.4	3.0	3.5	480	1020	1100	4.7	4.5	4.3
	25	3.4	—	—	1.4	3.4	4.0	480	1180	1240	5.4	5.2	5.0
	35	4.5	—	—	1.4	4.5	4.8	480	1470	1490	6.7	6.5	6.2
	50	5.8	—	—	1.4	5.8	6.0	480	1910	2260	8.8	8.4	8.0
2 room	20 + 20	2.95	2.95	—	2.0	5.9	7.0	540	1510	2580	6.9	6.6	6.4
	20 + 25	2.67	3.33	—	2.0	6.0	7.0	540	1560	2580	7.2	6.9	6.6
	20 + 35	2.29	4.01	—	2.0	6.3	7.0	540	1650	2580	7.6	7.2	6.9
	20 + 50	1.89	4.71	—	2.0	6.6	7.0	540	1740	2580	8.0	7.6	7.3
	25 + 25	3.05	3.05	—	2.0	6.1	7.0	540	1590	2580	7.3	7.0	6.7
	25 + 35	2.67	3.73	—	2.0	6.4	7.0	540	1680	2580	7.7	7.4	7.1
	25 + 50	2.20	4.40	—	2.0	6.6	7.0	540	1740	2580	8.0	7.6	7.3
	35 + 35	3.30	3.30	—	2.0	6.6	7.0	540	1740	2580	8.0	7.6	7.3
3 room	20 + 20 + 20	2.00	2.00	2.00	3.0	6.0	7.3	600	1340	2580	6.3	6.1	5.8
	20 + 20 + 25	1.91	1.91	2.38	3.0	6.2	7.3	600	1430	2580	6.8	6.5	6.2
	20 + 20 + 35	1.76	1.76	3.08	3.0	6.6	7.3	600	1600	2580	7.6	7.2	6.9
	20 + 25 + 25	1.83	2.29	2.29	3.0	6.4	7.3	600	1510	2580	7.1	6.8	6.6
	20 + 25 + 35	1.70	2.13	2.98	3.0	6.8	7.3	600	1660	2580	7.9	7.5	7.2
	25 + 25 + 25	2.20	2.20	2.20	3.0	6.6	7.3	600	1600	2580	7.6	7.2	6.9
	25 + 25 + 35	2.06	2.06	2.88	3.0	7.0	7.3	600	1730	2580	8.2	7.8	7.5

## (Cooling operation)

Indoor unit combination	Cooling capacity (kW)						Power consumption (W)			Standard current (A)			
	Room Cooling capacity (kW)			Total capacity (kW)			Min.	Standard	Max.	220V	230V	240V	
	A room	B room	C room	Min.	Standard	Max.							
1 room	20	2.0	—	—	1.8	2.0	2.7	500	580	900	2.7	2.5	2.4
	25	2.5	—	—	1.8	2.5	3.2	500	760	1070	3.5	3.3	3.2
	35	3.5	—	—	1.8	3.5	3.7	500	1140	1230	5.2	5.0	4.8
	50	5.0	—	—	1.8	5.0	5.3	500	1790	2000	8.2	7.9	7.5
2 room	20 + 20	2.00	2.00	—	3.0	4.0	5.6	570	950	1800	4.4	4.2	4.0
	20 + 25	1.91	2.39	—	3.0	4.3	5.8	570	1110	1980	5.1	4.9	4.7
	20 + 35	1.82	3.18	—	3.0	5.0	6.1	570	1490	2070	6.8	6.5	6.3
	20 + 50	1.71	4.29	—	3.0	6.0	6.3	570	2040	2150	9.4	9.0	8.6
	25 + 25	2.35	2.35	—	3.0	4.7	6.1	570	1320	2070	6.1	5.8	5.6
	25 + 35	2.21	3.09	—	3.0	5.3	6.3	570	1660	2150	7.6	7.3	7.0
	25 + 50	2.00	4.00	—	3.0	6.0	6.3	570	2040	2150	9.4	9.0	8.6
	35 + 35	3.00	3.00	—	3.0	6.0	6.3	570	2040	2150	9.4	9.0	8.6
3 room	20 + 20 + 20	1.67	1.67	1.67	3.4	5.0	6.9	690	1120	2150	5.3	5.1	4.9
	20 + 20 + 25	1.60	1.60	2.00	3.4	5.2	6.9	690	1200	2150	5.7	5.4	5.2
	20 + 20 + 35	1.49	1.49	2.61	3.4	5.6	6.9	690	1370	2150	6.5	6.2	5.9
	20 + 25 + 25	1.54	1.93	1.93	3.4	5.4	6.9	690	1300	2150	6.2	5.9	5.6
	20 + 25 + 35	1.45	1.81	2.54	3.4	5.8	6.9	690	1470	2150	7.0	6.7	6.4
	25 + 25 + 25	1.87	1.87	1.87	3.4	5.6	6.9	690	1370	2150	6.5	6.2	5.9
	25 + 25 + 35	1.76	1.76	2.47	3.4	6.0	6.9	690	1540	2150	7.3	7.0	6.7

## Table of Indoor unit combination SCM60ZJ-S <with all indoor unit SRK-ZJX-S type only> (Heating operation)

Indoor unit combination	Heating capacity (kW)						Power consumption (W)			Standard current (A)			
	Room heating capacity (kW)			Total capacity (kW)			Min.	Standard	Max.	220V	230V	240V	
	A room	B room	C room	Min.	Standard	Max.							
1 room	20	3.0	—	—	1.5	3.0	3.7	600	780	1330	3.6	3.4	3.3
	25	3.4	—	—	1.5	3.4	4.2	600	950	1510	4.4	4.2	4.0
	35	4.5	—	—	1.5	4.5	5.0	600	1290	1790	5.9	5.7	5.4
	50	5.8	—	—	1.5	5.8	6.4	600	1780	2310	8.2	7.8	7.5
	60	6.8	—	—	1.5	6.8	7.3	600	2120	2660	9.7	9.3	8.9

# INVERTER MULTI-SPLIT SYSTEM

## (Heating operation)

Indoor unit combination	Heating capacity (kW)						Power consumption (W)			Standard current (A)			
	Room heating capacity (kW)			Total capacity (kW)			Min.	Standard	Max.	220V	230V	240V	
	A room	B room	C room	Min.	Standard	Max.							
2 room	20 + 20	3.00	3.00	—	2.1	6.0	7.3	630	1490	2100	6.8	6.5	6.3
	20 + 25	2.71	3.39	—	2.1	6.1	7.5	630	1570	2550	7.2	6.9	6.6
	20 + 35	2.36	4.14	—	2.1	6.5	7.6	630	1680	3000	7.7	7.4	7.1
	20 + 50	2.00	5.00	—	2.1	7.0	7.6	630	1900	3000	8.7	8.3	8.0
	20 + 60	1.78	5.33	—	2.1	7.1	7.6	630	1940	3000	8.9	8.5	8.2
	25 + 25	3.15	3.15	—	2.1	6.3	7.6	630	1630	3000	7.5	7.2	6.9
	25 + 35	2.79	3.91	—	2.1	6.7	7.6	630	1760	3000	8.1	7.7	7.4
	25 + 50	2.37	4.73	—	2.1	7.1	7.6	630	1940	3000	8.9	8.5	8.2
	25 + 60	2.09	5.01	—	2.1	7.1	7.6	630	1940	3000	8.9	8.5	8.2
	35 + 35	3.50	3.50	—	2.1	7.0	7.6	630	1900	3000	8.7	8.3	8.0
	35 + 50	2.92	4.18	—	2.1	7.1	7.6	630	1940	3000	8.9	8.5	8.2
	35 + 60	2.62	4.48	—	2.1	7.1	7.6	630	1940	3000	8.9	8.5	8.2
50 + 50	3.55	3.55	—	2.1	7.1	7.6	630	1940	3000	8.9	8.5	8.2	
50 + 60	3.23	3.87	—	2.1	7.1	7.6	630	1940	3000	8.9	8.5	8.2	
3 room	20 + 20 + 20	2.20	2.20	2.20	3.2	6.6	7.8	660	1350	3000	6.4	6.1	5.9
	20 + 20 + 25	2.06	2.06	2.58	3.2	6.7	7.8	660	1390	3000	6.6	6.3	6.0
	20 + 20 + 35	1.81	1.81	3.17	3.2	6.8	7.8	660	1510	3000	7.1	6.8	6.6
	20 + 20 + 50	1.56	1.56	3.89	3.2	7.0	7.8	660	1690	3000	8.0	7.7	7.3
	20 + 20 + 60	1.44	1.44	4.32	3.2	7.2	7.8	660	1860	3000	8.8	8.4	8.1
	20 + 25 + 25	1.94	2.43	2.43	3.2	6.8	7.8	660	1510	3000	7.1	6.8	6.6
	20 + 25 + 35	1.73	2.16	3.02	3.2	6.9	7.8	660	1560	3000	7.4	7.1	6.8
	20 + 25 + 50	1.49	1.87	3.74	3.2	7.1	7.8	660	1740	3000	8.2	7.9	7.6
	20 + 25 + 60	1.37	1.71	4.11	3.2	7.2	7.8	660	1860	3000	8.8	8.4	8.1
	20 + 35 + 35	1.56	2.72	2.72	3.2	7.0	7.8	660	1690	3000	8.0	7.7	7.3
	20 + 35 + 50	1.37	2.40	3.43	3.2	7.2	7.8	660	1860	3000	8.8	8.4	8.1
	25 + 25 + 25	2.27	2.27	2.27	3.2	6.8	7.8	660	1510	3000	7.1	6.8	6.6
	25 + 25 + 35	2.06	2.06	2.88	3.2	7.0	7.8	660	1690	3000	8.0	7.7	7.3
	25 + 25 + 50	1.80	1.80	3.60	3.2	7.2	7.8	660	1860	3000	8.8	8.4	8.1
	25 + 25 + 60	1.64	1.64	3.93	3.2	7.2	7.8	660	1860	3000	8.8	8.4	8.1
	25 + 35 + 35	1.87	2.62	2.62	3.2	7.1	7.8	660	1740	3000	8.2	7.9	7.6
	25 + 35 + 50	1.64	2.29	3.27	3.2	7.2	7.8	660	1860	3000	8.8	8.4	8.1
	35 + 35 + 35	2.40	2.40	2.40	3.2	7.2	7.8	660	1860	3000	8.8	8.4	8.1

**Table of Indoor unit combination SCM60ZJ-S  
<with all indoor unit SRK-ZJX-S type only>  
(Cooling operation)**

Indoor unit combination	Cooling capacity (kW)						Power consumption (W)			Standard current (A)			
	Room Cooling capacity (kW)			Total capacity (kW)			Min.	Standard	Max.	220V	230V	240V	
	A room	B room	C room	Min.	Standard	Max.							
1 room	20	2.0	—	—	1.8	2.0	2.8	500	540	950	2.5	2.4	2.3
	25	2.5	—	—	1.8	2.5	3.4	500	720	1080	3.3	3.2	3.0
	35	3.5	—	—	1.8	3.5	3.9	500	1090	1240	5.0	4.8	4.6
	50	5.0	—	—	1.8	5.0	5.8	500	1780	2100	8.2	7.8	7.5
	60	6.0	—	—	1.8	6.0	6.3	500	2260	2370	10.4	9.9	9.5
2 room	20 + 20	2.00	2.00	—	3.0	4.0	5.7	570	750	1750	3.4	3.3	3.2
	20 + 25	2.00	2.50	—	3.0	4.5	5.9	570	990	1910	4.5	4.3	4.2
	20 + 35	1.93	3.37	—	3.0	5.3	6.2	570	1550	2110	7.1	6.8	6.5
	20 + 50	1.89	4.71	—	3.0	6.6	6.9	570	2280	2390	10.5	10.0	9.6
	20 + 60	1.68	5.03	—	3.0	6.7	6.9	570	2320	2390	10.7	10.2	9.8
	25 + 25	2.45	2.45	—	3.0	4.9	6.2	570	1270	2110	5.8	5.6	5.3
	25 + 35	2.42	3.38	—	3.0	5.8	6.5	570	1840	2270	8.4	8.1	7.7
	25 + 50	2.23	4.47	—	3.0	6.7	6.9	570	2320	2390	10.7	10.2	9.8
	25 + 60	1.97	4.73	—	3.0	6.7	6.9	570	2320	2390	10.7	10.2	9.8
	35 + 35	3.30	3.30	—	3.0	6.6	6.9	570	2280	2390	10.5	10.0	9.6
	35 + 50	2.76	3.94	—	3.0	6.7	6.9	570	2320	2390	10.7	10.2	9.8
	35 + 60	2.47	4.23	—	3.0	6.7	6.9	570	2320	2390	10.7	10.2	9.8
50 + 50	3.35	3.35	—	3.0	6.7	6.9	570	2320	2390	10.7	10.2	9.8	
50 + 60	3.05	3.65	—	3.0	6.7	6.9	570	2320	2390	10.7	10.2	9.8	
3 room	20 + 20 + 20	1.90	1.90	1.90	3.6	5.7	7.5	690	1390	2390	6.6	6.3	6.0
	20 + 20 + 25	1.82	1.82	2.27	3.6	5.9	7.5	690	1410	2390	6.7	6.4	6.1
	20 + 20 + 35	1.60	1.60	2.80	3.6	6.0	7.5	690	1430	2390	6.8	6.5	6.2
	20 + 20 + 50	1.40	1.40	3.50	3.6	6.3	7.5	690	1480	2390	7.0	6.7	6.4
	20 + 20 + 60	1.28	1.28	3.84	3.6	6.4	7.5	690	1500	2390	7.1	6.8	6.5
	20 + 25 + 25	1.69	2.11	2.11	3.6	5.9	7.5	690	1410	2390	6.7	6.4	6.1
	20 + 25 + 35	1.53	1.91	2.67	3.6	6.1	7.5	690	1460	2390	6.9	6.6	6.3
	20 + 25 + 50	1.35	1.68	3.37	3.6	6.4	7.5	690	1500	2390	7.1	6.8	6.5
	20 + 25 + 60	1.26	1.57	3.77	3.6	6.6	7.5	690	1520	2390	7.2	6.9	6.6
	20 + 35 + 35	1.40	2.45	2.45	3.6	6.3	7.5	690	1480	2390	7.0	6.7	6.4
	20 + 35 + 50	1.26	2.20	3.14	3.6	6.6	7.5	690	1520	2390	7.2	6.9	6.6
	25 + 25 + 25	2.00	2.00	2.00	3.6	6.0	7.5	690	1430	2390	6.8	6.5	6.2
	25 + 25 + 35	1.79	1.79	2.51	3.6	6.1	7.5	690	1460	2390	6.9	6.6	6.3
	25 + 25 + 50	1.60	1.60	3.20	3.6	6.4	7.5	690	1500	2390	7.1	6.8	6.5
	25 + 25 + 60	1.52	1.52	3.65	3.6	6.7	7.5	690	1540	2390	7.3	7.0	6.7
	25 + 35 + 35	1.68	2.36	2.36	3.6	6.4	7.5	690	1500	2390	7.1	6.8	6.5
	25 + 35 + 50	1.52	2.13	3.05	3.6	6.7	7.5	690	1540	2390	7.3	7.0	6.7
	35 + 35 + 35	2.20	2.20	2.20	3.6	6.6	7.5	690	1520	2390	7.2	6.9	6.6

**Table of Indoor unit combination SCM60ZJ-S**  
 <with indoor unit except all indoor unit SRK-ZJX-S type only>  
 (Heating operation)

Indoor unit combination	Heating capacity (kW)						Power consumption (W)			Standard current (A)			
	Room heating capacity (kW)			Total capacity (kW)			Min.	Standard	Max.	220V	230V	240V	
	A room	B room	C room	Min.	Standard	Max.							
1 room	20	3.0	—	—	1.5	3.0	3.5	600	970	1330	4.5	4.3	4.1
	25	3.4	—	—	1.5	3.4	4.0	600	1140	1510	5.2	5.0	4.8
	35	4.5	—	—	1.5	4.5	4.8	600	1480	1790	6.8	6.5	6.2
	50	5.8	—	—	1.5	5.8	6.1	600	1960	2310	9.0	8.6	8.2
	60	6.8	—	—	1.5	6.8	7.0	600	2250	2660	10.3	9.9	9.5
2 room	20 + 20	3.00	3.00	—	2.1	6.0	7.0	630	1520	2100	7.0	6.7	6.4
	20 + 25	2.71	3.39	—	2.1	6.1	7.2	630	1600	2550	7.3	7.0	6.7
	20 + 35	2.36	4.14	—	2.1	6.5	7.3	630	1710	3000	7.9	7.5	7.2
	20 + 50	2.00	5.00	—	2.1	7.0	7.3	630	1940	3000	8.9	8.5	8.2
	20 + 60	1.78	5.33	—	2.1	7.1	7.3	630	1980	3000	9.1	8.7	8.3
	25 + 25	3.15	3.15	—	2.1	6.3	7.3	630	1660	3000	7.6	7.3	7.0
	25 + 35	2.79	3.91	—	2.1	6.7	7.3	630	1790	3000	8.2	7.9	7.5
	25 + 50	2.37	4.73	—	2.1	7.1	7.3	630	1980	3000	9.1	8.7	8.3
	25 + 60	2.09	5.01	—	2.1	7.1	7.3	630	1980	3000	9.1	8.7	8.3
	35 + 35	3.50	3.50	—	2.1	7.0	7.3	630	1940	3000	8.9	8.5	8.2
	35 + 50	2.92	4.18	—	2.1	7.1	7.3	630	1980	3000	9.1	8.7	8.3
	35 + 60	2.62	4.48	—	2.1	7.1	7.3	630	1980	3000	9.1	8.7	8.3
	50 + 50	3.55	3.55	—	2.1	7.1	7.3	630	1980	3000	9.1	8.7	8.3
	50 + 60	3.23	3.87	—	2.1	7.1	7.3	630	1980	3000	9.1	8.7	8.3
	3 room	20 + 20 + 20	2.20	2.20	2.20	3.2	6.6	7.6	660	1380	3000	6.5	6.3
20 + 20 + 25		2.06	2.06	2.58	3.2	6.7	7.6	660	1420	3000	6.7	6.4	6.2
20 + 20 + 35		1.81	1.81	3.17	3.2	6.8	7.6	660	1540	3000	7.3	7.0	6.7
20 + 20 + 50		1.56	1.56	3.89	3.2	7.0	7.6	660	1730	3000	8.2	7.8	7.5
20 + 20 + 60		1.44	1.44	4.32	3.2	7.2	7.6	660	1900	3000	9.0	8.6	8.2
20 + 25 + 25		1.94	2.43	2.43	3.2	6.8	7.6	660	1540	3000	7.3	7.0	6.7
20 + 25 + 35		1.73	2.16	3.02	3.2	6.9	7.6	660	1590	3000	7.5	7.2	6.9
20 + 25 + 50		1.49	1.87	3.74	3.2	7.1	7.6	660	1780	3000	8.4	8.1	7.7
20 + 25 + 60		1.37	1.71	4.11	3.2	7.2	7.6	660	1900	3000	9.0	8.6	8.2
20 + 35 + 35		1.56	2.72	2.72	3.2	7.0	7.6	660	1730	3000	8.2	7.8	7.5
20 + 35 + 50		1.37	2.40	3.43	3.2	7.2	7.6	660	1900	3000	9.0	8.6	8.2
25 + 25 + 25		2.27	2.27	2.27	3.2	6.8	7.6	660	1540	3000	7.3	7.0	6.7
25 + 25 + 35		2.06	2.06	2.88	3.2	7.0	7.6	660	1730	3000	8.2	7.8	7.5
25 + 25 + 50		1.80	1.80	3.60	3.2	7.2	7.6	660	1900	3000	9.0	8.6	8.2
25 + 25 + 60		1.64	1.64	3.93	3.2	7.2	7.6	660	1900	3000	9.0	8.6	8.2
25 + 35 + 35		1.87	2.62	2.62	3.2	7.1	7.6	660	1780	3000	8.4	8.1	7.7
25 + 35 + 50		1.64	2.29	3.27	3.2	7.2	7.6	660	1900	3000	9.0	8.6	8.2
35 + 35 + 35		2.40	2.40	2.40	3.2	7.2	7.6	660	1900	3000	9.0	8.6	8.2

**Table of Indoor unit combination SCM60ZJ-S**  
 <with indoor unit except all indoor unit SRK-ZJX-S type only>  
 (Cooling operation)

Indoor unit combination	Cooling capacity (kW)						Power consumption (W)			Standard current (A)			
	Room Cooling capacity (kW)			Total capacity (kW)			Min.	Standard	Max.	220V	230V	240V	
	A room	B room	C room	Min.	Standard	Max.							
1 room	20	2.0	—	—	1.8	2.0	2.7	500	570	950	2.6	2.5	2.4
	25	2.5	—	—	1.8	2.5	3.2	500	760	1080	3.5	3.3	3.2
	35	3.5	—	—	1.8	3.5	3.7	500	1150	1240	5.3	5.1	4.8
	50	5.0	—	—	1.8	5.0	5.6	500	1860	2100	8.5	8.2	7.8
	60	6.0	—	—	1.8	6.0	6.1	500	2350	2370	10.8	10.3	9.9
2 room	20 + 20	2.00	2.00	—	3.0	4.0	5.6	570	800	1750	3.7	3.5	3.4
	20 + 25	2.00	2.50	—	3.0	4.5	5.8	570	1050	1910	4.8	4.6	4.4
	20 + 35	1.93	3.37	—	3.0	5.3	6.1	570	1620	2110	7.4	7.1	6.8
	20 + 50	1.89	4.71	—	3.0	6.6	6.8	570	2330	2390	10.7	10.2	9.8
	20 + 60	1.68	5.03	—	3.0	6.7	6.8	570	2370	2390	10.9	10.4	10.0
	25 + 25	2.45	2.45	—	3.0	4.9	6.1	570	1340	2110	6.2	5.9	5.6
	25 + 35	2.42	3.38	—	3.0	5.8	6.4	570	1920	2270	8.8	8.4	8.1
	25 + 50	2.23	4.47	—	3.0	6.7	6.8	570	2370	2390	10.9	10.4	10.0
	25 + 60	1.97	4.73	—	3.0	6.7	6.8	570	2370	2390	10.9	10.4	10.0
	35 + 35	3.30	3.30	—	3.0	6.6	6.8	570	2330	2390	10.7	10.2	9.8
	35 + 50	2.76	3.94	—	3.0	6.7	6.8	570	2370	2390	10.9	10.4	10.0
	35 + 60	2.47	4.23	—	3.0	6.7	6.8	570	2370	2390	10.9	10.4	10.0
	50 + 50	3.35	3.35	—	3.0	6.7	6.8	570	2370	2390	10.9	10.4	10.0
	50 + 60	3.05	3.65	—	3.0	6.7	6.8	570	2370	2390	10.9	10.4	10.0
	3 room	20 + 20 + 20	1.90	1.90	1.90	3.6	5.7	7.3	690	1430	2390	6.8	6.5
20 + 20 + 25		1.82	1.82	2.27	3.6	5.9	7.3	690	1450	2390	6.9	6.6	6.3
20 + 20 + 35		1.60	1.60	2.80	3.6	6.0	7.3	690	1470	2390	7.0	6.7	6.4
20 + 20 + 50		1.40	1.40	3.50	3.6	6.3	7.3	690	1520	2390	7.2	6.9	6.6
20 + 20 + 60		1.28	1.28	3.84	3.6	6.4	7.3	690	1540	2390	7.3	7.0	6.7
20 + 25 + 25		1.69	2.11	2.11	3.6	5.9	7.3	690	1450	2390	6.9	6.6	6.3
20 + 25 + 35		1.53	1.91	2.67	3.6	6.1	7.3	690	1500	2390	7.1	6.8	6.5
20 + 25 + 50		1.35	1.68	3.37	3.6	6.4	7.3	690	1540	2390	7.3	7.0	6.7
20 + 25 + 60		1.26	1.57	3.77	3.6	6.6	7.3	690	1560	2390	7.4	7.1	6.8
20 + 35 + 35		1.40	2.45	2.45	3.6	6.3	7.3	690	1520	2390	7.2	6.9	6.6
20 + 35 + 50		1.26	2.20	3.14	3.6	6.6	7.3	690	1560	2390	7.4	7.1	6.8
25 + 25 + 25		2.00	2.00	2.00	3.6	6.0	7.3	690	1470	2390	7.0	6.7	6.4
25 + 25 + 35		1.79	1.79	2.51	3.6	6.1	7.3	690	1500	2390	7.1	6.8	6.5
25 + 25 + 50		1.60	1.60	3.20	3.6	6.4	7.3	690	1540	2390	7.3	7.0	6.7
25 + 25 + 60		1.52	1.52	3.65	3.6	6.7	7.3	690	1580	2390	7.5	7.2	6.9
25 + 35 + 35		1.68	2.36	2.36	3.6	6.4	7.3	690	1540	2390	7.3	7.0	6.7
25 + 35 + 50		1.52	2.13	3.05	3.6	6.7	7.3	690	1580	2390	7.5	7.2	6.9
35 + 35 + 35		2.20	2.20	2.20	3.6	6.6	7.3	690	1560	2390	7.4	7.1	6.8

# INVERTER MULTI-SPLIT SYSTEM

**Table of Indoor unit combination SCM71ZJ-S  
<with all indoor unit SRK-ZJX-S type only>  
(Heating operation)**

Indoor unit combination	Heating capacity (kW)							Power consumption (W)			Standard current (A)			
	Room heating capacity (kW)				Total capacity (kW)			Min.	Standard	Max.	220V	230V	240V	
	A room	B room	C room	D room	Min.	Standard	Max.							
1 room	20	3.0	—	—	—	1.5	3.0	3.7	600	840	1330	3.9	3.7	3.5
	25	3.4	—	—	—	1.5	3.4	4.2	600	1000	1510	4.6	4.4	4.2
	35	4.5	—	—	—	1.5	4.5	5.0	600	1330	1790	6.1	5.8	5.6
	50	5.8	—	—	—	1.5	5.8	6.5	600	1780	2310	8.2	7.8	7.5
	60	6.8	—	—	—	1.5	6.8	7.5	600	2100	2660	9.6	9.2	8.8
2 room	20 + 20	2.70	2.70	—	—	2.1	5.4	7.4	630	1340	1870	6.2	5.9	5.6
	20 + 25	2.62	3.28	—	—	2.1	5.9	7.7	630	1530	2130	7.0	6.7	6.4
	20 + 35	2.51	4.39	—	—	2.1	6.9	8.3	630	1910	2650	8.8	8.4	8.0
	20 + 50	2.34	5.86	—	—	2.1	8.2	8.7	630	2430	3350	11.2	10.7	10.2
	20 + 60	2.05	6.15	—	—	2.1	8.2	8.7	630	2430	3350	11.2	10.7	10.2
	25 + 25	3.20	3.20	—	—	2.1	6.4	8.1	630	1700	2480	7.8	7.5	7.2
	25 + 35	3.08	4.32	—	—	2.1	7.4	8.6	630	2090	2910	9.6	9.2	8.8
	25 + 50	2.73	5.47	—	—	2.1	8.2	8.7	630	2430	3350	11.2	10.7	10.2
	25 + 60	2.41	5.79	—	—	2.1	8.2	8.7	630	2430	3350	11.2	10.7	10.2
	35 + 35	4.10	4.10	—	—	2.1	8.2	8.7	630	2430	3350	11.2	10.7	10.2
	35 + 50	3.38	4.82	—	—	2.1	8.2	8.7	630	2430	3350	11.2	10.7	10.2
	35 + 60	3.02	5.18	—	—	2.1	8.2	8.7	630	2430	3350	11.2	10.7	10.2
	50 + 50	4.10	4.10	—	—	2.1	8.2	8.7	630	2430	3350	11.2	10.7	10.2
	50 + 60	3.73	4.47	—	—	2.1	8.2	8.7	630	2430	3350	11.2	10.7	10.2
60 + 60	4.10	4.10	—	—	2.1	8.2	8.7	630	2430	3350	11.2	10.7	10.2	
3 room	20 + 20 + 20	2.57	2.57	2.57	—	3.2	7.7	9.1	660	1830	3350	8.4	8.0	7.7
	20 + 20 + 25	2.46	2.46	3.08	—	3.2	8.0	9.1	660	1930	3350	8.9	8.5	8.1
	20 + 20 + 35	2.24	2.24	3.92	—	3.2	8.4	9.1	660	2060	3350	9.5	9.0	8.7
	20 + 20 + 50	1.87	1.87	4.67	—	3.2	8.4	9.1	660	2060	3350	9.5	9.0	8.7
	20 + 20 + 60	1.68	1.68	5.04	—	3.2	8.4	9.1	660	2060	3350	9.5	9.0	8.7
	20 + 25 + 25	2.34	2.93	2.93	—	3.2	8.2	9.1	660	1990	3350	9.1	8.7	8.4
	20 + 25 + 35	2.10	2.63	3.68	—	3.2	8.4	9.1	660	2060	3350	9.5	9.0	8.7
	20 + 25 + 50	1.77	2.21	4.42	—	3.2	8.4	9.1	660	2060	3350	9.5	9.0	8.7
	20 + 25 + 60	1.60	2.00	4.80	—	3.2	8.4	9.1	660	2060	3350	9.5	9.0	8.7
	20 + 35 + 35	1.87	3.27	3.27	—	3.2	8.4	9.1	660	2060	3350	9.5	9.0	8.7
	20 + 35 + 50	1.60	2.80	4.00	—	3.2	8.4	9.1	660	2060	3350	9.5	9.0	8.7
	20 + 35 + 60	1.46	2.56	4.38	—	3.2	8.4	9.1	660	2060	3350	9.5	9.0	8.7
	20 + 50 + 50	1.40	3.50	3.50	—	3.2	8.4	9.1	660	2060	3350	9.5	9.0	8.7
	25 + 25 + 25	2.80	2.80	2.80	—	3.2	8.4	9.1	660	2060	3350	9.5	9.0	8.7
	25 + 25 + 35	2.47	2.47	3.46	—	3.2	8.4	9.1	660	2060	3350	9.5	9.0	8.7
	25 + 25 + 50	2.10	2.10	4.20	—	3.2	8.4	9.1	660	2060	3350	9.5	9.0	8.7
	25 + 25 + 60	1.91	1.91	4.58	—	3.2	8.4	9.1	660	2060	3350	9.5	9.0	8.7
	25 + 35 + 35	2.21	3.09	3.09	—	3.2	8.4	9.1	660	2060	3350	9.5	9.0	8.7
	25 + 35 + 50	1.91	2.67	3.82	—	3.2	8.4	9.1	660	2060	3350	9.5	9.0	8.7
	25 + 35 + 60	1.75	2.45	4.20	—	3.2	8.4	9.1	660	2060	3350	9.5	9.0	8.7
25 + 50 + 50	1.68	3.36	3.36	—	3.2	8.4	9.1	660	2060	3350	9.5	9.0	8.7	
35 + 35 + 35	2.80	2.80	2.80	—	3.2	8.4	9.1	660	2060	3350	9.5	9.0	8.7	
35 + 35 + 50	2.45	2.45	3.50	—	3.2	8.4	9.1	660	2060	3350	9.5	9.0	8.7	
4 room	20 + 20 + 20 + 20	2.10	2.10	2.10	2.10	3.6	8.4	9.4	800	1960	3350	9.0	8.6	8.2
	20 + 20 + 20 + 25	1.98	1.98	1.98	2.47	3.6	8.4	9.4	800	1960	3350	9.0	8.6	8.2
	20 + 20 + 20 + 35	1.79	1.79	1.79	3.13	3.6	8.5	9.4	800	1980	3350	9.1	8.7	8.3
	20 + 20 + 20 + 50	1.56	1.56	1.56	3.91	3.6	8.6	9.4	800	2000	3350	9.2	8.8	8.4
	20 + 20 + 20 + 60	1.43	1.43	1.43	4.30	3.6	8.6	9.4	800	2000	3350	9.2	8.8	8.4
	20 + 20 + 25 + 25	1.89	1.89	2.36	2.36	3.6	8.5	9.4	800	1980	3350	9.1	8.7	8.3
	20 + 20 + 25 + 35	1.70	1.70	2.13	2.98	3.6	8.5	9.4	800	1980	3350	9.1	8.7	8.3
	20 + 20 + 25 + 50	1.50	1.50	1.87	3.74	3.6	8.6	9.4	800	2000	3350	9.2	8.8	8.4
	20 + 20 + 25 + 60	1.38	1.38	1.72	4.13	3.6	8.6	9.4	800	2000	3350	9.2	8.8	8.4
	20 + 20 + 35 + 35	1.56	1.56	2.74	2.74	3.6	8.6	9.4	800	2000	3350	9.2	8.8	8.4
	20 + 20 + 35 + 50	1.38	1.38	2.41	3.44	3.6	8.6	9.4	800	2000	3350	9.2	8.8	8.4
	20 + 25 + 25 + 25	1.79	2.24	2.24	2.24	3.6	8.5	9.4	800	1980	3350	9.1	8.7	8.3
	20 + 25 + 25 + 35	1.64	2.05	2.05	2.87	3.6	8.6	9.4	800	2000	3350	9.2	8.8	8.4
	20 + 25 + 25 + 50	1.43	1.79	1.79	3.58	3.6	8.6	9.4	800	2000	3350	9.2	8.8	8.4
	20 + 25 + 35 + 35	1.50	1.87	2.62	2.62	3.6	8.6	9.4	800	2000	3350	9.2	8.8	8.4
	20 + 35 + 35 + 35	1.38	2.41	2.41	2.41	3.6	8.6	9.4	800	2000	3350	9.2	8.8	8.4
	25 + 25 + 25 + 25	2.13	2.13	2.13	2.13	3.6	8.5	9.4	800	1980	3350	9.1	8.7	8.3
	25 + 25 + 25 + 35	1.95	1.95	1.95	2.74	3.6	8.6	9.4	800	2000	3350	9.2	8.8	8.4
	25 + 25 + 25 + 50	1.72	1.72	1.72	3.44	3.6	8.6	9.4	800	2000	3350	9.2	8.8	8.4
	25 + 25 + 35 + 35	1.79	1.79	2.51	2.51	3.6	8.6	9.4	800	2000	3350	9.2	8.8	8.4

**Table of Indoor unit combination SCM71ZJ-S  
<with all indoor unit SRK-ZJX-S type only>  
(Cooling operation)**

Indoor unit combination	Cooling capacity (kW)							Power consumption (W)			Standard current (A)			
	Room cooling capacity (kW)				Total capacity (kW)			Min.	Standard	Max.	220V	230V	240V	
	A room	B room	C room	D room	Min.	Standard	Max.							
1 room	20	2.0	—	—	—	1.8	2.0	2.8	480	500	950	2.3	2.2	2.1
	25	2.5	—	—	—	1.8	2.5	3.4	480	680	1080	3.1	3.0	2.9
	35	3.5	—	—	—	1.8	3.5	3.9	480	1010	1240	4.6	4.4	4.3
	50	5.0	—	—	—	1.8	5.0	6.1	480	1530	2100	7.0	6.7	6.4
	60	6.0	—	—	—	1.8	6.0	7.0	480	1880	2700	8.6	8.3	7.9
2 room	20 + 20	2.00	2.00	—	—	3.0	4.0	6.1	550	850	1910	3.9	3.7	3.6
	20 + 25	2.00	2.50	—	—	3.0	4.5	6.4	550	1070	2060	4.9	4.7	4.5
	20 + 35	2.00	3.50	—	—	3.0	5.5	6.9	550	1470	2320	6.7	6.5	6.2
	20 + 50	1.94	4.86	—	—	3.0	6.8	7.7	550	2030	2750	9.3	8.9	8.5
	20 + 60	1.70	5.10	—	—	3.0	6.8	7.7	550	2030	2750	9.3	8.9	8.5
	25 + 25	2.50	2.50	—	—	3.0	5.0	6.8	550	1250	2270	5.7	5.5	5.3
	25 + 35	2.46	3.44	—	—	3.0	5.9	7.2	550	1660	2470	7.6	7.3	7.0
	25 + 50	2.27	4.53	—	—	3.0	6.8	7.7	550	2030	2750	9.3	8.9	8.5
	25 + 60	2.00	4.80	—	—	3.0	6.8	7.7	550	2030	2750	9.3	8.9	8.5
	35 + 35	3.40	3.40	—	—	3.0	6.8	7.6	550	2030	2680	9.3	8.9	8.5
	35 + 50	2.80	4.00	—	—	3.0	6.8	7.7	550	2030	2750	9.3	8.9	8.5
	35 + 60	2.51	4.29	—	—	3.0	6.8	7.7	550	2030	2750	9.3	8.9	8.5
	50 + 50	3.40	3.40	—	—	3.0	6.8	7.7	550	2030	2750	9.3	8.9	8.5
	50 + 60	3.09	3.71	—	—	3.0	6.8	7.7	550	2030	2750	9.3	8.9	8.5
60 + 60	3.40	3.40	—	—	3.0	6.8	7.7	550	2030	2750	9.3	8.9	8.5	
3 room	20 + 20 + 20	2.00	2.00	2.00	—	3.7	6.0	8.2	670	1380	2750	6.3	6.1	5.8
	20 + 20 + 25	2.00	2.00	2.50	—	3.7	6.5	8.2	670	1560	2750	7.2	6.9	6.6
	20 + 20 + 35	1.84	1.84	3.22	—	3.7	6.9	8.2	670	1830	2750	8.4	8.0	7.7
	20 + 20 + 50	1.53	1.53	3.83	—	3.7	6.9	8.2	670	1830	2750	8.4	8.0	7.7
	20 + 20 + 60	1.38	1.38	4.14	—	3.7	6.9	8.2	670	1830	2750	8.4	8.0	7.7
	20 + 25 + 25	1.94	2.43	2.43	—	3.7	6.8	8.2	670	1740	2750	8.0	7.6	7.3
	20 + 25 + 35	1.73	2.16	3.02	—	3.7	6.9	8.2	670	1830	2750	8.4	8.0	7.7
	20 + 25 + 50	1.45	1.82	3.63	—	3.7	6.9	8.2	670	1830	2750	8.4	8.0	7.7
	20 + 25 + 60	1.31	1.64	3.94	—	3.7	6.9	8.2	670	1830	2750	8.4	8.0	7.7
	20 + 35 + 35	1.53	2.68	2.68	—	3.7	6.9	8.2	670	1830	2750	8.4	8.0	7.7
	20 + 35 + 50	1.31	2.30	3.29	—	3.7	6.9	8.2	670	1830	2750	8.4	8.0	7.7
	20 + 35 + 60	1.20	2.10	3.60	—	3.7	6.9	8.2	670	1830	2750	8.4	8.0	7.7
	20 + 50 + 50	1.15	2.88	2.88	—	3.7	6.9	8.2	670	1830	2750	8.4	8.0	7.7
	25 + 25 + 25	2.30	2.30	2.30	—	3.7	6.9	8.2	670	1830	2750	8.4	8.0	7.7
	25 + 25 + 35	2.03	2.03	2.84	—	3.7	6.9	8.2	670	1830	2750	8.4	8.0	7.7
	25 + 25 + 50	1.73	1.73	3.45	—	3.7	6.9	8.2	670	1830	2750	8.4	8.0	7.7
	25 + 25 + 60	1.57	1.57	3.76	—	3.7	6.9	8.2	670	1830	2750	8.4	8.0	7.7
	25 + 35 + 35	1.82	2.54	2.54	—	3.7	6.9	8.2	670	1830	2750	8.4	8.0	7.7
	25 + 35 + 50	1.57	2.20	3.14	—	3.7	6.9	8.2	670	1830	2750	8.4	8.0	7.7
	25 + 35 + 60	1.44	2.01	3.45	—	3.7	6.9	8.2	670	1830	2750	8.4	8.0	7.7
25 + 50 + 50	1.38	2.76	2.76	—	3.7	6.9	8.2	670	1830	2750	8.4	8.0	7.7	
35 + 35 + 35	2.30	2.30	2.30	—	3.7	6.9	8.2	670	1830	2750	8.4	8.0	7.7	
35 + 35 + 50	2.01	2.01	2.88	—	3.7	6.9	8.2	670	1830	2750	8.4	8.0	7.7	
4 room	20 + 20 + 20 + 20	1.73	1.73	1.73	1.73	4.4	6.9	8.8	890	1700	2750	7.8	7.5	7.2
	20 + 20 + 20 + 25	1.62	1.62	1.62	2.03	4.4	6.9	8.8	890	1700	2750	7.8	7.5	7.2
	20 + 20 + 20 + 35	1.49	1.49	1.49	2.62	4.4	7.1	8.8	890	1740	2750	8.0	7.6	7.3
	20 + 20 + 20 + 50	1.29	1.29	1.29	3.23	4.4	7.1	8.8	890	1740	2750	8.0	7.6	7.3
	20 + 20 + 20 + 60	1.18	1.18	1.18	3.55	4.4	7.1	8.8	890	1740	2750	8.0	7.6	7.3
	20 + 20 + 25 + 25	1.53	1.53	1.92	1.92	4.4	6.9	8.8	890	1700	2750	7.8	7.5	7.2
	20 + 20 + 25 + 35	1.42	1.42	1.78	2.49	4.4	7.1	8.8	890	1740	2750	8.0	7.6	7.3
	20 + 20 + 25 + 50	1.23	1.23	1.54	3.09	4.4	7.1	8.8	890	1740	2750	8.0	7.6	7.3
	20 + 20 + 25 + 60	1.14	1.14	1.42	3.41	4.4	7.1	8.8	890	1740	2750	8.0	7.6	7.3
	20 + 20 + 35 + 35	1.29	1.29	2.26	2.26	4.4	7.1	8.8	890	1740	2750	8.0	7.6	7.3
	20 + 20 + 35 + 50	1.14	1.14	1.99	2.84	4.4	7.1	8.8	890	1740	2750	8.0	7.6	7.3
	20 + 25 + 25 + 25	1.49	1.87	1.87	1.87	4.4	7.1	8.8	890	1740	2750	8.0	7.6	7.3
	20 + 25 + 25 + 35	1.35	1.69	1.69	2.37	4.4	7.1	8.8	890	1740	2750	8.0	7.6	7.3
	20 + 25 + 25 + 50	1.18	1.48	1.48	2.96	4.4	7.1	8.8	890	1740	2750	8.0	7.6	7.3
	20 + 25 + 35 + 35	1.23	1.54	2.16	2.16	4.4	7.1	8.8	890	1740	2750	8.0	7.6	7.3
	20 + 35 + 35 + 35	1.14	1.99	1.99	1.99	4.4	7.1	8.8	890	1740	2750	8.0	7.6	7.3
	25 + 25 + 25 + 25	1.78	1.78	1.78	1.78	4.4	7.1	8.8	890	1740	2750	8.0	7.6	7.3
	25 + 25 + 25 + 35	1.61	1.61	1.61	2.26	4.4	7.1	8.8	890	1740	2750	8.0	7.6	7.3
	25 + 25 + 25 + 50	1.42	1.42	1.42	2.84	4.4	7.1	8.8	890	1740	2750	8.0	7.6	7.3
	25 + 25 + 35 + 35	1.48	1.48	2.07	2.07	4.4	7.1	8.8	890	1740	2750	8.0	7.6	7.3

# INVERTER MULTI-SPLIT SYSTEM

**Table of Indoor unit combination SCM71ZJ-S  
<with indoor unit except all indoor unit SRK-ZJX-S type only>  
(Heating operation)**

Indoor unit combination	Heating capacity (kW)							Power consumption (W)			Standard current (A)			
	Room heating capacity (kW)				Total capacity (kW)			Min.	Standard	Max.	220V	230V	240V	
	A room	B room	C room	D room	Min.	Standard	Max.							
1 room	20	3.0	—	—	—	1.5	3.0	3.5	600	1060	1330	4.9	4.7	4.5
	25	3.4	—	—	—	1.5	3.4	4.0	600	1220	1510	5.6	5.4	5.1
	35	4.5	—	—	—	1.5	4.5	4.8	600	1510	1790	6.9	6.6	6.4
	50	5.8	—	—	—	1.5	5.8	6.2	600	1950	2310	9.0	8.6	8.2
	60	6.8	—	—	—	1.5	6.8	7.1	600	2240	2660	10.3	9.8	9.4
2 room	20 + 20	2.70	2.70	—	—	2.1	5.4	7.0	630	1370	1870	6.3	6.0	5.8
	20 + 25	2.62	3.28	—	—	2.1	5.9	7.3	630	1560	2130	7.2	6.9	6.6
	20 + 35	2.51	4.39	—	—	2.1	6.9	7.9	630	1950	2650	9.0	8.6	8.2
	20 + 50	2.34	5.86	—	—	2.1	8.2	8.3	630	2490	3350	11.4	10.9	10.5
	20 + 60	2.05	6.15	—	—	2.1	8.2	8.3	630	2490	3350	11.4	10.9	10.5
	25 + 25	3.20	3.20	—	—	2.1	6.4	7.7	630	1740	2480	8.0	7.6	7.3
	25 + 35	3.08	4.32	—	—	2.1	7.4	8.2	630	2130	2910	9.8	9.4	9.0
	25 + 50	2.73	5.47	—	—	2.1	8.2	8.3	630	2490	3350	11.4	10.9	10.5
	25 + 60	2.41	5.79	—	—	2.1	8.2	8.3	630	2490	3350	11.4	10.9	10.5
	35 + 35	4.10	4.10	—	—	2.1	8.2	8.3	630	2490	3350	11.4	10.9	10.5
	35 + 50	3.38	4.82	—	—	2.1	8.2	8.3	630	2490	3350	11.4	10.9	10.5
	35 + 60	3.02	5.18	—	—	2.1	8.2	8.3	630	2490	3350	11.4	10.9	10.5
	50 + 50	4.10	4.10	—	—	2.1	8.2	8.3	630	2490	3350	11.4	10.9	10.5
	50 + 60	3.73	4.47	—	—	2.1	8.2	8.3	630	2490	3350	11.4	10.9	10.5
60 + 60	4.10	4.10	—	—	2.1	8.2	8.3	630	2490	3350	11.4	10.9	10.5	
3 room	20 + 20 + 20	2.57	2.57	2.57	—	3.2	7.7	8.9	660	1870	3350	8.6	8.2	7.9
	20 + 20 + 25	2.46	2.46	3.08	—	3.2	8.0	8.9	660	1970	3350	9.0	8.7	8.3
	20 + 20 + 35	2.24	2.24	3.92	—	3.2	8.4	8.9	660	2100	3350	9.6	9.2	8.8
	20 + 20 + 50	1.87	1.87	4.67	—	3.2	8.4	8.9	660	2100	3350	9.6	9.2	8.8
	20 + 20 + 60	1.68	1.68	5.04	—	3.2	8.4	8.9	660	2100	3350	9.6	9.2	8.8
	20 + 25 + 25	2.34	2.93	2.93	—	3.2	8.2	8.9	660	2030	3350	9.3	8.9	8.5
	20 + 25 + 35	2.10	2.63	3.68	—	3.2	8.4	8.9	660	2100	3350	9.6	9.2	8.8
	20 + 25 + 50	1.77	2.21	4.42	—	3.2	8.4	8.9	660	2100	3350	9.6	9.2	8.8
	20 + 25 + 60	1.60	2.00	4.80	—	3.2	8.4	8.9	660	2100	3350	9.6	9.2	8.8
	20 + 35 + 35	1.87	3.27	3.27	—	3.2	8.4	8.9	660	2100	3350	9.6	9.2	8.8
	20 + 35 + 50	1.60	2.80	4.00	—	3.2	8.4	8.9	660	2100	3350	9.6	9.2	8.8
	20 + 35 + 60	1.46	2.56	4.38	—	3.2	8.4	8.9	660	2100	3350	9.6	9.2	8.8
	20 + 50 + 50	1.40	3.50	3.50	—	3.2	8.4	8.9	660	2100	3350	9.6	9.2	8.8
	25 + 25 + 25	2.80	2.80	2.80	—	3.2	8.4	8.9	660	2100	3350	9.6	9.2	8.8
	25 + 25 + 35	2.47	2.47	3.46	—	3.2	8.4	8.9	660	2100	3350	9.6	9.2	8.8
	25 + 25 + 50	2.10	2.10	4.20	—	3.2	8.4	8.9	660	2100	3350	9.6	9.2	8.8
	25 + 25 + 60	1.91	1.91	4.58	—	3.2	8.4	8.9	660	2100	3350	9.6	9.2	8.8
	25 + 35 + 35	2.21	3.09	3.09	—	3.2	8.4	8.9	660	2100	3350	9.6	9.2	8.8
	25 + 35 + 50	1.91	2.67	3.82	—	3.2	8.4	8.9	660	2100	3350	9.6	9.2	8.8
	25 + 35 + 60	1.75	2.45	4.20	—	3.2	8.4	8.9	660	2100	3350	9.6	9.2	8.8
25 + 50 + 50	1.68	3.36	3.36	—	3.2	8.4	8.9	660	2100	3350	9.6	9.2	8.8	
35 + 35 + 35	2.80	2.80	2.80	—	3.2	8.4	8.9	660	2100	3350	9.6	9.2	8.8	
35 + 35 + 50	2.45	2.45	3.50	—	3.2	8.4	8.9	660	2100	3350	9.6	9.2	8.8	
4 room	20 + 20 + 20 + 20	2.10	2.10	2.10	2.10	3.6	8.4	9.1	800	2010	3350	9.2	8.8	8.5
	20 + 20 + 20 + 25	1.98	1.98	1.98	2.47	3.6	8.4	9.1	800	2010	3350	9.2	8.8	8.5
	20 + 20 + 20 + 35	1.79	1.79	1.79	3.13	3.6	8.5	9.1	800	2030	3350	9.3	8.9	8.5
	20 + 20 + 20 + 50	1.56	1.56	1.56	3.91	3.6	8.6	9.1	800	2050	3350	9.4	9.0	8.6
	20 + 20 + 20 + 60	1.43	1.43	1.43	4.30	3.6	8.6	9.1	800	2050	3350	9.4	9.0	8.6
	20 + 20 + 25 + 25	1.89	1.89	2.36	2.36	3.6	8.5	9.1	800	2030	3350	9.3	8.9	8.5
	20 + 20 + 25 + 35	1.70	1.70	2.13	2.98	3.6	8.5	9.1	800	2030	3350	9.3	8.9	8.5
	20 + 20 + 25 + 50	1.50	1.50	1.87	3.74	3.6	8.6	9.1	800	2050	3350	9.4	9.0	8.6
	20 + 20 + 25 + 60	1.38	1.38	1.72	4.13	3.6	8.6	9.1	800	2050	3350	9.4	9.0	8.6
	20 + 20 + 35 + 35	1.56	1.56	2.74	2.74	3.6	8.6	9.1	800	2050	3350	9.4	9.0	8.6
	20 + 20 + 35 + 50	1.38	1.38	2.41	3.44	3.6	8.6	9.1	800	2050	3350	9.4	9.0	8.6
	20 + 25 + 25 + 25	1.79	2.24	2.24	2.24	3.6	8.5	9.1	800	2030	3350	9.3	8.9	8.5
	20 + 25 + 25 + 35	1.64	2.05	2.05	2.87	3.6	8.6	9.1	800	2050	3350	9.4	9.0	8.6
	20 + 25 + 25 + 50	1.43	1.79	1.79	3.58	3.6	8.6	9.1	800	2050	3350	9.4	9.0	8.6
	20 + 25 + 35 + 35	1.50	1.87	2.62	2.62	3.6	8.6	9.1	800	2050	3350	9.4	9.0	8.6
	20 + 35 + 35 + 35	1.38	2.41	2.41	2.41	3.6	8.6	9.1	800	2050	3350	9.4	9.0	8.6
	25 + 25 + 25 + 25	2.13	2.13	2.13	2.13	3.6	8.5	9.1	800	2030	3350	9.3	8.9	8.5
	25 + 25 + 25 + 35	1.95	1.95	1.95	2.74	3.6	8.6	9.1	800	2050	3350	9.4	9.0	8.6
	25 + 25 + 25 + 50	1.72	1.72	1.72	3.44	3.6	8.6	9.1	800	2050	3350	9.4	9.0	8.6
	25 + 25 + 35 + 35	1.79	1.79	2.51	2.51	3.6	8.6	9.1	800	2050	3350	9.4	9.0	8.6

**Table of Indoor unit combination SCM71ZJ-S  
<with indoor unit except all indoor unit SRK-ZJX-S type only>  
(Cooling operation)**

Indoor unit combination	Cooling capacity (kW)							Power consumption (W)			Standard current (A)			
	Room cooling capacity (kW)				Total capacity (kW)			Min.	Standard	Max.	220V	230V	240V	
	A room	B room	C room	D room	Min.	Standard	Max.							
1 room	20	2.0	—	—	—	1.8	2.0	2.7	480	530	950	2.4	2.3	2.2
	25	2.5	—	—	—	1.8	2.5	3.2	480	730	1080	3.4	3.2	3.1
	35	3.5	—	—	—	1.8	3.5	3.7	480	1120	1240	5.1	4.9	4.7
	50	5.0	—	—	—	1.8	5.0	5.8	480	1710	2100	7.9	7.5	7.2
	60	6.0	—	—	—	1.8	6.0	6.7	480	2140	2700	9.8	9.4	9.0
2 room	20 + 20	2.00	2.00	—	—	3.0	4.0	5.8	550	930	1910	4.3	4.1	3.9
	20 + 25	2.00	2.50	—	—	3.0	4.5	6.1	550	1170	2060	5.4	5.1	4.9
	20 + 35	2.00	3.50	—	—	3.0	5.5	6.6	550	1590	2320	7.3	7.0	6.7
	20 + 50	1.94	4.86	—	—	3.0	6.8	7.3	550	2150	2750	9.9	9.4	9.0
	20 + 60	1.70	5.10	—	—	3.0	6.8	7.3	550	2150	2750	9.9	9.4	9.0
	25 + 25	2.50	2.50	—	—	3.0	5.0	6.5	550	1360	2270	6.2	6.0	5.7
	25 + 35	2.46	3.44	—	—	3.0	5.9	6.8	550	1780	2470	8.2	7.8	7.5
	25 + 50	2.27	4.53	—	—	3.0	6.8	7.3	550	2150	2750	9.9	9.4	9.0
	25 + 60	2.00	4.80	—	—	3.0	6.8	7.3	550	2150	2750	9.9	9.4	9.0
	35 + 35	3.40	3.40	—	—	3.0	6.8	7.2	550	2150	2680	9.9	9.4	9.0
	35 + 50	2.80	4.00	—	—	3.0	6.8	7.3	550	2150	2750	9.9	9.4	9.0
	35 + 60	2.51	4.29	—	—	3.0	6.8	7.3	550	2150	2750	9.9	9.4	9.0
	50 + 50	3.40	3.40	—	—	3.0	6.8	7.3	550	2150	2750	9.9	9.4	9.0
	50 + 60	3.09	3.71	—	—	3.0	6.8	7.3	550	2150	2750	9.9	9.4	9.0
	60 + 60	3.40	3.40	—	—	3.0	6.8	7.3	550	2150	2750	9.9	9.4	9.0
3 room	20 + 20 + 20	2.00	2.00	2.00	—	3.7	6.0	7.8	670	1450	2750	6.7	6.4	6.1
	20 + 20 + 25	2.00	2.00	2.50	—	3.7	6.5	7.8	670	1630	2750	7.5	7.2	6.9
	20 + 20 + 35	1.84	1.84	3.22	—	3.7	6.9	7.8	670	1910	2750	8.8	8.4	8.0
	20 + 20 + 50	1.53	1.53	3.83	—	3.7	6.9	7.8	670	1910	2750	8.8	8.4	8.0
	20 + 20 + 60	1.38	1.38	4.14	—	3.7	6.9	7.8	670	1910	2750	8.8	8.4	8.0
	20 + 25 + 25	1.94	2.43	2.43	—	3.7	6.8	7.8	670	1820	2750	8.4	8.0	7.7
	20 + 25 + 35	1.73	2.16	3.02	—	3.7	6.9	7.8	670	1910	2750	8.8	8.4	8.0
	20 + 25 + 50	1.45	1.82	3.63	—	3.7	6.9	7.8	670	1910	2750	8.8	8.4	8.0
	20 + 25 + 60	1.31	1.64	3.94	—	3.7	6.9	7.8	670	1910	2750	8.8	8.4	8.0
	20 + 35 + 35	1.53	2.68	2.68	—	3.7	6.9	7.8	670	1910	2750	8.8	8.4	8.0
	20 + 35 + 50	1.31	2.30	3.29	—	3.7	6.9	7.8	670	1910	2750	8.8	8.4	8.0
	20 + 35 + 60	1.20	2.10	3.60	—	3.7	6.9	7.8	670	1910	2750	8.8	8.4	8.0
	20 + 50 + 50	1.15	2.88	2.88	—	3.7	6.9	7.8	670	1910	2750	8.8	8.4	8.0
	25 + 25 + 25	2.30	2.30	2.30	—	3.7	6.9	7.8	670	1910	2750	8.8	8.4	8.0
	25 + 25 + 35	2.03	2.03	2.84	—	3.7	6.9	7.8	670	1910	2750	8.8	8.4	8.0
	25 + 25 + 50	1.73	1.73	3.45	—	3.7	6.9	7.8	670	1910	2750	8.8	8.4	8.0
	25 + 25 + 60	1.57	1.57	3.76	—	3.7	6.9	7.8	670	1910	2750	8.8	8.4	8.0
	25 + 35 + 35	1.82	2.54	2.54	—	3.7	6.9	7.8	670	1910	2750	8.8	8.4	8.0
	25 + 35 + 50	1.57	2.20	3.14	—	3.7	6.9	7.8	670	1910	2750	8.8	8.4	8.0
	25 + 35 + 60	1.44	2.01	3.45	—	3.7	6.9	7.8	670	1910	2750	8.8	8.4	8.0
25 + 50 + 50	1.38	2.76	2.76	—	3.7	6.9	7.8	670	1910	2750	8.8	8.4	8.0	
35 + 35 + 35	2.30	2.30	2.30	—	3.7	6.9	7.8	670	1910	2750	8.8	8.4	8.0	
35 + 35 + 50	2.01	2.01	2.88	—	3.7	6.9	7.8	670	1910	2750	8.8	8.4	8.0	
4 room	20 + 20 + 20 + 20	1.73	1.73	1.73	1.73	4.4	6.9	8.3	890	1750	2750	8.0	7.7	7.4
	20 + 20 + 20 + 25	1.62	1.62	1.62	2.03	4.4	6.9	8.3	890	1750	2750	8.0	7.7	7.4
	20 + 20 + 20 + 35	1.49	1.49	1.49	2.62	4.4	7.1	8.3	890	1790	2750	8.2	7.9	7.5
	20 + 20 + 20 + 50	1.29	1.29	1.29	3.23	4.4	7.1	8.3	890	1790	2750	8.2	7.9	7.5
	20 + 20 + 20 + 60	1.18	1.18	1.18	3.55	4.4	7.1	8.3	890	1790	2750	8.2	7.9	7.5
	20 + 20 + 25 + 25	1.53	1.53	1.92	1.92	4.4	6.9	8.3	890	1750	2750	8.0	7.7	7.4
	20 + 20 + 25 + 35	1.42	1.42	1.78	2.49	4.4	7.1	8.3	890	1790	2750	8.2	7.9	7.5
	20 + 20 + 25 + 50	1.23	1.23	1.54	3.09	4.4	7.1	8.3	890	1790	2750	8.2	7.9	7.5
	20 + 20 + 25 + 60	1.14	1.14	1.42	3.41	4.4	7.1	8.3	890	1790	2750	8.2	7.9	7.5
	20 + 20 + 35 + 35	1.29	1.29	2.26	2.26	4.4	7.1	8.3	890	1790	2750	8.2	7.9	7.5
	20 + 20 + 35 + 50	1.14	1.14	1.99	2.84	4.4	7.1	8.3	890	1790	2750	8.2	7.9	7.5
	20 + 25 + 25 + 25	1.49	1.87	1.87	1.87	4.4	7.1	8.3	890	1790	2750	8.2	7.9	7.5
	20 + 25 + 25 + 35	1.35	1.69	1.69	2.37	4.4	7.1	8.3	890	1790	2750	8.2	7.9	7.5
	20 + 25 + 25 + 50	1.18	1.48	1.48	2.96	4.4	7.1	8.3	890	1790	2750	8.2	7.9	7.5
	20 + 25 + 35 + 35	1.23	1.54	2.16	2.16	4.4	7.1	8.3	890	1790	2750	8.2	7.9	7.5
	20 + 35 + 35 + 35	1.14	1.99	1.99	1.99	4.4	7.1	8.3	890	1790	2750	8.2	7.9	7.5
	25 + 25 + 25 + 25	1.78	1.78	1.78	1.78	4.4	7.1	8.3	890	1790	2750	8.2	7.9	7.5
	25 + 25 + 25 + 35	1.61	1.61	1.61	2.26	4.4	7.1	8.3	890	1790	2750	8.2	7.9	7.5
	25 + 25 + 25 + 50	1.42	1.42	1.42	2.84	4.4	7.1	8.3	890	1790	2750	8.2	7.9	7.5
	25 + 25 + 35 + 35	1.48	1.48	2.07	2.07	4.4	7.1	8.3	890	1790	2750	8.2	7.9	7.5

# INVERTER MULTI-SPLIT SYSTEM

**Table of Indoor unit combination SCM80ZJ-S  
<with all indoor unit SRK-ZJX-S type only>  
(Heating operation)**

Indoor unit combination	Heating capacity (kW)							Power consumption (W)			Standard current (A)			
	Room heating capacity (kW)				Total capacity (kW)			Min.	Standard	Max.	220V	230V	240V	
	A room	B room	C room	D room	Min.	Standard	Max.							
1 room	20	3.0	—	—	—	1.5	3.0	3.7	600	840	1330	3.9	3.7	3.5
	25	3.4	—	—	—	1.5	3.4	4.2	600	1000	1510	4.6	4.4	4.2
	35	4.5	—	—	—	1.5	4.5	5.0	600	1330	1790	6.1	5.8	5.6
	50	5.8	—	—	—	1.5	5.8	6.5	600	1780	2310	8.2	7.8	7.5
	60	6.8	—	—	—	1.5	6.8	7.5	600	2100	2660	9.6	9.2	8.8
2 room	20 + 20	2.70	2.70	—	—	2.1	5.4	7.4	630	1340	1870	6.2	5.9	5.6
	20 + 25	2.62	3.28	—	—	2.1	5.9	7.7	630	1530	2130	7.0	6.7	6.4
	20 + 35	2.51	4.39	—	—	2.1	6.9	8.3	630	1910	2650	8.8	8.4	8.0
	20 + 50	2.37	5.93	—	—	2.1	8.3	8.8	630	2460	3430	11.3	10.8	10.4
	20 + 60	2.08	6.23	—	—	2.1	8.3	8.8	630	2460	3430	11.3	10.8	10.4
	25 + 25	3.20	3.20	—	—	2.1	6.4	8.1	630	1700	2480	7.8	7.5	7.2
	25 + 35	3.08	4.32	—	—	2.1	7.4	8.6	630	2090	2910	9.6	9.2	8.8
	25 + 50	2.77	5.53	—	—	2.1	8.3	8.8	630	2460	3430	11.3	10.8	10.4
	25 + 60	2.44	5.86	—	—	2.1	8.3	8.8	630	2460	3430	11.3	10.8	10.4
	35 + 35	4.15	4.15	—	—	2.1	8.3	8.8	630	2460	3430	11.3	10.8	10.4
	35 + 50	3.42	4.88	—	—	2.1	8.3	8.8	630	2460	3430	11.3	10.8	10.4
	35 + 60	3.06	5.24	—	—	2.1	8.3	8.8	630	2460	3430	11.3	10.8	10.4
	50 + 50	4.15	4.15	—	—	2.1	8.3	8.8	630	2460	3430	11.3	10.8	10.4
	50 + 60	3.77	4.53	—	—	2.1	8.3	8.8	630	2460	3430	11.3	10.8	10.4
	60 + 60	4.15	4.15	—	—	2.1	8.3	8.8	630	2460	3430	11.3	10.8	10.4
3 room	20 + 20 + 20	2.57	2.57	2.57	—	3.2	7.7	9.3	660	1830	3430	8.4	8.0	7.7
	20 + 20 + 25	2.46	2.46	3.08	—	3.2	8.0	9.3	660	1930	3430	8.9	8.5	8.1
	20 + 20 + 35	2.27	2.27	3.97	—	3.2	8.5	9.3	660	2090	3430	9.6	9.2	8.8
	20 + 20 + 50	2.00	2.00	5.00	—	3.2	9.0	9.3	660	2250	3430	10.3	9.9	9.5
	20 + 20 + 60	1.80	1.80	5.40	—	3.2	9.0	9.3	660	2250	3430	10.3	9.9	9.5
	20 + 25 + 25	2.34	2.93	2.93	—	3.2	8.2	9.3	660	1990	3430	9.1	8.7	8.4
	20 + 25 + 35	2.20	2.75	3.85	—	3.2	8.8	9.3	660	2180	3430	10.0	9.6	9.2
	20 + 25 + 50	1.89	2.37	4.74	—	3.2	9.0	9.3	660	2250	3430	10.3	9.9	9.5
	20 + 25 + 60	1.71	2.14	5.14	—	3.2	9.0	9.3	660	2250	3430	10.3	9.9	9.5
	20 + 35 + 35	2.00	3.50	3.50	—	3.2	9.0	9.3	660	2250	3430	10.3	9.9	9.5
	20 + 35 + 50	1.71	3.00	4.29	—	3.2	9.0	9.3	660	2250	3430	10.3	9.9	9.5
	20 + 35 + 60	1.57	2.74	4.70	—	3.2	9.0	9.3	660	2250	3430	10.3	9.9	9.5
	20 + 50 + 50	1.50	3.75	3.75	—	3.2	9.0	9.3	660	2250	3430	10.3	9.9	9.5
	20 + 50 + 60	1.38	3.46	4.15	—	3.2	9.0	9.3	660	2250	3430	10.3	9.9	9.5
	25 + 25 + 25	2.83	2.83	2.83	—	3.2	8.5	9.3	660	2090	3430	9.6	9.2	8.8
	25 + 25 + 35	2.65	2.65	3.71	—	3.2	9.0	9.3	660	2250	3430	10.3	9.9	9.5
	25 + 25 + 50	2.25	2.25	4.50	—	3.2	9.0	9.3	660	2250	3430	10.3	9.9	9.5
	25 + 25 + 60	2.05	2.05	4.91	—	3.2	9.0	9.3	660	2250	3430	10.3	9.9	9.5
	25 + 35 + 35	2.37	3.32	3.32	—	3.2	9.0	9.3	660	2250	3430	10.3	9.9	9.5
	25 + 35 + 50	2.05	2.86	4.09	—	3.2	9.0	9.3	660	2250	3430	10.3	9.9	9.5
	25 + 35 + 60	1.88	2.63	4.50	—	3.2	9.0	9.3	660	2250	3430	10.3	9.9	9.5
	25 + 50 + 50	1.80	3.60	3.60	—	3.2	9.0	9.3	660	2250	3430	10.3	9.9	9.5
	25 + 50 + 60	1.67	3.33	4.00	—	3.2	9.0	9.3	660	2250	3430	10.3	9.9	9.5
	35 + 35 + 35	3.00	3.00	3.00	—	3.2	9.0	9.3	660	2250	3430	10.3	9.9	9.5
	35 + 35 + 50	2.63	2.63	3.75	—	3.2	9.0	9.3	660	2250	3430	10.3	9.9	9.5
35 + 35 + 60	2.42	2.42	4.15	—	3.2	9.0	9.3	660	2250	3430	10.3	9.9	9.5	
35 + 50 + 50	2.33	3.33	3.33	—	3.2	9.0	9.3	660	2250	3430	10.3	9.9	9.5	
4 room	20 + 20 + 20 + 20	2.28	2.28	2.28	2.28	3.6	9.1	9.8	800	2220	3430	10.2	9.7	9.3
	20 + 20 + 20 + 25	2.14	2.14	2.14	2.68	3.6	9.1	9.8	800	2220	3430	10.2	9.7	9.3
	20 + 20 + 20 + 35	1.94	1.94	1.94	3.39	3.6	9.2	9.8	800	2240	3430	10.3	9.8	9.4
	20 + 20 + 20 + 50	1.67	1.67	1.67	4.18	3.6	9.2	9.8	800	2240	3430	10.3	9.8	9.4
	20 + 20 + 20 + 60	1.55	1.55	1.55	4.65	3.6	9.3	9.8	800	2260	3430	10.4	10.0	9.5
	20 + 20 + 25 + 25	2.04	2.04	2.56	2.56	3.6	9.2	9.8	800	2240	3430	10.3	9.8	9.4
	20 + 20 + 25 + 35	1.84	1.84	2.30	3.22	3.6	9.2	9.8	800	2240	3430	10.3	9.8	9.4
	20 + 20 + 25 + 50	1.62	1.62	2.02	4.04	3.6	9.3	9.8	800	2260	3430	10.4	10.0	9.5
	20 + 20 + 25 + 60	1.49	1.49	1.86	4.46	3.6	9.3	9.8	800	2260	3430	10.4	10.0	9.5
	20 + 20 + 35 + 35	1.67	1.67	2.93	2.93	3.6	9.2	9.8	800	2240	3430	10.3	9.8	9.4
	20 + 20 + 35 + 50	1.49	1.49	2.60	3.72	3.6	9.3	9.8	800	2260	3430	10.4	10.0	9.5
	20 + 20 + 35 + 60	1.38	1.38	2.41	4.13	3.6	9.3	9.8	800	2260	3430	10.4	10.0	9.5
	20 + 25 + 25 + 25	1.94	2.42	2.42	2.42	3.6	9.2	9.8	800	2240	3430	10.3	9.8	9.4
	20 + 25 + 25 + 35	1.75	2.19	2.19	3.07	3.6	9.2	9.8	800	2240	3430	10.3	9.8	9.4
	20 + 25 + 25 + 50	1.55	1.94	1.94	3.88	3.6	9.3	9.8	800	2260	3430	10.4	10.0	9.5
	20 + 25 + 25 + 60	1.43	1.79	1.79	4.29	3.6	9.3	9.8	800	2260	3430	10.4	10.0	9.5
	20 + 25 + 35 + 35	1.62	2.02	2.83	2.83	3.6	9.3	9.8	800	2260	3430	10.4	10.0	9.5
	20 + 25 + 35 + 50	1.43	1.79	2.50	3.58	3.6	9.3	9.8	800	2260	3430	10.4	10.0	9.5
	20 + 35 + 35 + 35	1.49	2.60	2.60	2.60	3.6	9.3	9.8	800	2260	3430	10.4	10.0	9.5
	25 + 25 + 25 + 25	2.30	2.30	2.30	2.30	3.6	9.2	9.8	800	2240	3430	10.3	9.8	9.4
	25 + 25 + 25 + 35	2.09	2.09	2.09	2.93	3.6	9.2	9.8	800	2240	3430	10.3	9.8	9.4
	25 + 25 + 25 + 50	1.86	1.86	1.86	3.72	3.6	9.3	9.8	800	2260	3430	10.4	10.0	9.5
	25 + 25 + 25 + 60	1.72	1.72	1.72	4.13	3.6	9.3	9.8	800	2260	3430	10.4	10.0	9.5
	25 + 25 + 35 + 35	1.94	1.94	2.71	2.71	3.6	9.3	9.8	800	2260	3430	10.4	10.0	9.5
	25 + 25 + 35 + 50	1.72	1.72	2.41	3.44	3.6	9.3	9.8	800	2260	3430	10.4	10.0	9.5
25 + 35 + 35 + 35	1.79	2.50	2.50	2.50	3.6	9.3	9.8	800	2260	3430	10.4	10.0	9.5	

**Table of Indoor unit combination SCM80ZJ-S  
<with all indoor unit SRK-ZJX-S type only>  
(Cooling operation)**

Indoor unit combination	Cooling capacity (kW)							Power consumption (W)			Standard current (A)			
	Room cooling capacity (kW)				Total capacity (kW)			Min.	Standard	Max.	220V	230V	240V	
	A room	B room	C room	D room	Min.	Standard	Max.							
1 room	20	2.0	—	—	—	1.8	2.0	2.8	480	500	950	2.3	2.2	2.1
	25	2.5	—	—	—	1.8	2.5	3.4	480	680	1080	3.1	3.0	2.9
	35	3.5	—	—	—	1.8	3.5	3.9	480	1010	1240	4.6	4.4	4.3
	50	5.0	—	—	—	1.8	5.0	6.1	480	1530	2100	7.0	6.7	6.4
	60	6.0	—	—	—	1.8	6.0	7.0	480	1880	2700	8.6	8.3	7.9
2 room	20 + 20	2.00	2.00	—	—	3.0	4.0	6.1	550	850	1910	3.9	3.7	3.6
	20 + 25	2.00	2.50	—	—	3.0	4.5	6.4	550	1070	2060	4.9	4.7	4.5
	20 + 35	2.00	3.50	—	—	3.0	5.5	6.9	550	1470	2320	6.7	6.5	6.2
	20 + 50	1.97	4.93	—	—	3.0	6.9	7.9	550	2070	2830	9.5	9.1	8.7
	20 + 60	1.85	5.55	—	—	3.0	7.4	7.9	550	2290	2830	10.5	10.1	9.6
	25 + 25	2.50	2.50	—	—	3.0	5.0	6.8	550	1250	2270	5.7	5.5	5.3
	25 + 35	2.46	3.44	—	—	3.0	5.9	7.2	550	1660	2470	7.6	7.3	7.0
	25 + 50	2.47	4.93	—	—	3.0	7.4	7.9	550	2290	2830	10.5	10.1	9.6
	25 + 60	2.18	5.22	—	—	3.0	7.4	7.9	550	2290	2830	10.5	10.1	9.6
	35 + 35	3.45	3.45	—	—	3.0	6.9	7.6	550	2070	2680	9.5	9.1	8.7
	35 + 50	3.05	4.35	—	—	3.0	7.4	7.9	550	2290	2830	10.5	10.1	9.6
	35 + 60	2.73	4.67	—	—	3.0	7.4	7.9	550	2290	2830	10.5	10.1	9.6
	50 + 50	3.70	3.70	—	—	3.0	7.4	7.9	550	2290	2830	10.5	10.1	9.6
	50 + 60	3.36	4.04	—	—	3.0	7.4	7.9	550	2290	2830	10.5	10.1	9.6
	60 + 60	3.70	3.70	—	—	3.0	7.4	7.9	550	2290	2830	10.5	10.1	9.6
3 room	20 + 20 + 20	2.00	2.00	2.00	—	3.7	6.0	8.5	670	1380	2830	6.3	6.1	5.8
	20 + 20 + 25	2.00	2.00	2.50	—	3.7	6.5	8.5	670	1560	2830	7.2	6.9	6.6
	20 + 20 + 35	1.89	1.89	3.31	—	3.7	7.1	8.5	670	1880	2830	8.6	8.3	7.9
	20 + 20 + 50	1.73	1.73	4.33	—	3.7	7.8	8.5	670	2230	2830	10.2	9.8	9.4
	20 + 20 + 60	1.56	1.56	4.68	—	3.7	7.8	8.5	670	2230	2830	10.2	9.8	9.4
	20 + 25 + 25	1.94	2.43	2.43	—	3.7	6.8	8.5	670	1740	2830	8.0	7.6	7.3
	20 + 25 + 35	1.88	2.34	3.28	—	3.7	7.5	8.5	670	2050	2830	9.4	9.0	8.6
	20 + 25 + 50	1.64	2.05	4.11	—	3.7	7.8	8.5	670	2230	2830	10.2	9.8	9.4
	20 + 25 + 60	1.49	1.86	4.46	—	3.7	7.8	8.5	670	2230	2830	10.2	9.8	9.4
	20 + 35 + 35	1.73	3.03	3.03	—	3.7	7.8	8.5	670	2230	2830	10.2	9.8	9.4
	20 + 35 + 50	1.49	2.60	3.71	—	3.7	7.8	8.5	670	2230	2830	10.2	9.8	9.4
	20 + 35 + 60	1.36	2.37	4.07	—	3.7	7.8	8.5	670	2230	2830	10.2	9.8	9.4
	20 + 50 + 50	1.30	3.25	3.25	—	3.7	7.8	8.5	670	2230	2830	10.2	9.8	9.4
	20 + 50 + 60	1.20	3.00	3.60	—	3.7	7.8	8.5	670	2230	2830	10.2	9.8	9.4
	25 + 25 + 25	2.37	2.37	2.37	—	3.7	7.1	8.5	670	1880	2830	8.6	8.3	7.9
	25 + 25 + 35	2.29	2.29	3.21	—	3.7	7.8	8.5	670	2230	2830	10.2	9.8	9.4
	25 + 25 + 50	1.95	1.95	3.90	—	3.7	7.8	8.5	670	2230	2830	10.2	9.8	9.4
	25 + 25 + 60	1.77	1.77	4.25	—	3.7	7.8	8.5	670	2230	2830	10.2	9.8	9.4
	25 + 35 + 35	2.05	2.87	2.87	—	3.7	7.8	8.5	670	2230	2830	10.2	9.8	9.4
	25 + 35 + 50	1.77	2.48	3.55	—	3.7	7.8	8.5	670	2230	2830	10.2	9.8	9.4
	25 + 35 + 60	1.63	2.28	3.90	—	3.7	7.8	8.5	670	2230	2830	10.2	9.8	9.4
	25 + 50 + 50	1.56	3.12	3.12	—	3.7	7.8	8.5	670	2230	2830	10.2	9.8	9.4
	25 + 50 + 60	1.44	2.89	3.47	—	3.7	7.8	8.5	670	2230	2830	10.2	9.8	9.4
	35 + 35 + 35	2.60	2.60	2.60	—	3.7	7.8	8.5	670	2230	2830	10.2	9.8	9.4
	35 + 35 + 50	2.28	2.28	3.25	—	3.7	7.8	8.5	670	2230	2830	10.2	9.8	9.4
35 + 35 + 60	2.10	2.10	3.60	—	3.7	7.8	8.5	670	2230	2830	10.2	9.8	9.4	
35 + 50 + 50	2.02	2.89	2.89	—	3.7	7.8	8.5	670	2230	2830	10.2	9.8	9.4	
4 room	20 + 20 + 20 + 20	1.95	1.95	1.95	1.95	4.4	7.8	9.2	890	2120	2830	9.6	9.2	8.8
	20 + 20 + 20 + 25	1.84	1.84	1.84	2.29	4.4	7.8	9.2	890	2120	2830	9.6	9.2	8.8
	20 + 20 + 20 + 35	1.66	1.66	1.66	2.91	4.4	7.9	9.2	890	2140	2830	9.7	9.3	8.9
	20 + 20 + 20 + 50	1.44	1.44	1.44	3.59	4.4	7.9	9.2	890	2140	2830	9.7	9.3	8.9
	20 + 20 + 20 + 60	1.33	1.33	1.33	4.00	4.4	8.0	9.2	890	2160	2830	9.9	9.4	9.0
	20 + 20 + 25 + 25	1.76	1.76	2.19	2.19	4.4	7.9	9.2	890	2140	2830	9.7	9.3	8.9
	20 + 20 + 25 + 35	1.58	1.58	1.98	2.77	4.4	7.9	9.2	890	2140	2830	9.7	9.3	8.9
	20 + 20 + 25 + 50	1.37	1.37	1.72	3.43	4.4	7.9	9.2	890	2140	2830	9.7	9.3	8.9
	20 + 20 + 25 + 60	1.28	1.28	1.60	3.84	4.4	8.0	9.2	890	2160	2830	9.9	9.4	9.0
	20 + 20 + 35 + 35	1.44	1.44	2.51	2.51	4.4	7.9	9.2	890	2140	2830	9.7	9.3	8.9
	20 + 20 + 35 + 50	1.28	1.28	2.24	3.20	4.4	8.0	9.2	890	2160	2830	9.9	9.4	9.0
	20 + 20 + 35 + 60	1.19	1.19	2.07	3.56	4.4	8.0	9.2	890	2160	2830	9.9	9.4	9.0
	20 + 25 + 25 + 25	1.66	2.08	2.08	2.08	4.4	7.9	9.2	890	2140	2830	9.7	9.3	8.9
	20 + 25 + 25 + 35	1.50	1.88	1.88	2.63	4.4	7.9	9.2	890	2140	2830	9.7	9.3	8.9
	20 + 25 + 25 + 50	1.33	1.67	1.67	3.33	4.4	8.0	9.2	890	2160	2830	9.9	9.4	9.0
	20 + 25 + 25 + 60	1.23	1.54	1.54	3.69	4.4	8.0	9.2	890	2160	2830	9.9	9.4	9.0
	20 + 25 + 35 + 35	1.37	1.72	2.40	2.40	4.4	7.9	9.2	890	2140	2830	9.7	9.3	8.9
	20 + 25 + 35 + 50	1.23	1.54	2.15	3.08	4.4	8.0	9.2	890	2160	2830	9.9	9.4	9.0
	20 + 35 + 35 + 35	1.28	2.24	2.24	2.24	4.4	8.0	9.2	890	2160	2830	9.9	9.4	9.0
	25 + 25 + 25 + 25	1.98	1.98	1.98	1.98	4.4	7.9	9.2	890	2140	2830	9.7	9.3	8.9
	25 + 25 + 25 + 35	1.80	1.80	1.80	2.51	4.4	7.9	9.2	890	2140	2830	9.7	9.3	8.9
	25 + 25 + 25 + 50	1.60	1.60	1.60	3.20	4.4	8.0	9.2	890	2160	2830	9.9	9.4	9.0
	25 + 25 + 25 + 60	1.48	1.48	1.48	3.56	4.4	8.0	9.2	890	2160	2830	9.9	9.4	9.0
	25 + 25 + 35 + 35	1.67	1.67	2.33	2.33	4.4	8.0	9.2	890	2160	2830	9.9	9.4	9.0
	25 + 25 + 35 + 50	1.48	1.48	2.07	2.96	4.4	8.0	9.2	890	2160	2830	9.9	9.4	9.0
25 + 35 + 35 + 35	1.54	2.15	2.15	2.15	4.4	8.0	9.2	890	2160	2830	9.9	9.4	9.0	

# INVERTER MULTI-SPLIT SYSTEM

**Table of Indoor unit combination SCM80ZJ-S**  
**<with indoor unit except all indoor unit SRK-ZJX-S type only>**  
**(Heating operation)**

Indoor unit combination	Heating capacity (kW)							Power consumption (W)			Standard current (A)			
	Room heating capacity (kW)				Total capacity (kW)			Min.	Standard	Max.	220V	230V	240V	
	A room	B room	C room	D room	Min.	Standard	Max.							
1 room	20	3.0	—	—	—	1.5	3.0	3.5	600	1060	1330	4.9	4.7	4.5
	25	3.4	—	—	—	1.5	3.4	4.0	600	1220	1510	5.6	5.4	5.1
	35	4.5	—	—	—	1.5	4.5	4.8	600	1510	1790	6.9	6.6	6.4
	50	5.8	—	—	—	1.5	5.8	6.2	600	1950	2310	9.0	8.6	8.2
	60	6.8	—	—	—	1.5	6.8	7.1	600	2240	2660	10.3	9.8	9.4
2 room	20 + 20	2.70	2.70	—	—	2.1	5.4	7.0	630	1370	1870	6.3	6.0	5.8
	20 + 25	2.62	3.28	—	—	2.1	5.9	7.3	630	1560	2130	7.2	6.9	6.6
	20 + 35	2.51	4.39	—	—	2.1	6.9	7.9	630	1950	2650	9.0	8.6	8.2
	20 + 50	2.37	5.93	—	—	2.1	8.3	8.4	630	2510	3430	11.5	11.0	10.6
	20 + 60	2.08	6.23	—	—	2.1	8.3	8.4	630	2510	3430	11.5	11.0	10.6
	25 + 25	3.20	3.20	—	—	2.1	6.4	7.7	630	1740	2480	8.0	7.6	7.3
	25 + 35	3.08	4.32	—	—	2.1	7.4	8.2	630	2130	2910	9.8	9.4	9.0
	25 + 50	2.77	5.53	—	—	2.1	8.3	8.4	630	2510	3430	11.5	11.0	10.6
	25 + 60	2.44	5.86	—	—	2.1	8.3	8.4	630	2510	3430	11.5	11.0	10.6
	35 + 35	4.15	4.15	—	—	2.1	8.3	8.4	630	2510	3430	11.5	11.0	10.6
	35 + 50	3.42	4.88	—	—	2.1	8.3	8.4	630	2510	3430	11.5	11.0	10.6
	35 + 60	3.06	5.24	—	—	2.1	8.3	8.4	630	2510	3430	11.5	11.0	10.6
	50 + 50	4.15	4.15	—	—	2.1	8.3	8.4	630	2510	3430	11.5	11.0	10.6
50 + 60	3.77	4.53	—	—	2.1	8.3	8.4	630	2510	3430	11.5	11.0	10.6	
60 + 60	4.15	4.15	—	—	2.1	8.3	8.4	630	2510	3430	11.5	11.0	10.6	
3 room	20 + 20 + 20	2.57	2.57	2.57	—	3.2	7.7	9.1	660	1870	3430	8.6	8.2	7.9
	20 + 20 + 25	2.46	2.46	3.08	—	3.2	8.0	9.1	660	1970	3430	9.0	8.7	8.3
	20 + 20 + 35	2.27	2.27	3.97	—	3.2	8.5	9.1	660	2130	3430	9.8	9.4	9.0
	20 + 20 + 50	2.00	2.00	5.00	—	3.2	9.0	9.1	660	2300	3430	10.6	10.1	9.7
	20 + 20 + 60	1.80	1.80	5.40	—	3.2	9.0	9.1	660	2300	3430	10.6	10.1	9.7
	20 + 25 + 25	2.34	2.93	2.93	—	3.2	8.2	9.1	660	2030	3430	9.3	8.9	8.5
	20 + 25 + 35	2.20	2.75	3.85	—	3.2	8.8	9.1	660	2220	3430	10.2	9.7	9.3
	20 + 25 + 50	1.89	2.37	4.74	—	3.2	9.0	9.1	660	2300	3430	10.6	10.1	9.7
	20 + 25 + 60	1.71	2.14	5.14	—	3.2	9.0	9.1	660	2300	3430	10.6	10.1	9.7
	20 + 35 + 35	2.00	3.50	3.50	—	3.2	9.0	9.1	660	2300	3430	10.6	10.1	9.7
	20 + 35 + 50	1.71	3.00	4.29	—	3.2	9.0	9.1	660	2300	3430	10.6	10.1	9.7
	20 + 35 + 60	1.57	2.74	4.70	—	3.2	9.0	9.1	660	2300	3430	10.6	10.1	9.7
	20 + 50 + 50	1.50	3.75	3.75	—	3.2	9.0	9.1	660	2300	3430	10.6	10.1	9.7
	20 + 50 + 60	1.38	3.46	4.15	—	3.2	9.0	9.1	660	2300	3430	10.6	10.1	9.7
	25 + 25 + 25	2.83	2.83	2.83	—	3.2	8.5	9.1	660	2130	3430	9.8	9.4	9.0
	25 + 25 + 35	2.65	2.65	3.71	—	3.2	9.0	9.1	660	2300	3430	10.6	10.1	9.7
	25 + 25 + 50	2.25	2.25	4.50	—	3.2	9.0	9.1	660	2300	3430	10.6	10.1	9.7
	25 + 25 + 60	2.05	2.05	4.91	—	3.2	9.0	9.1	660	2300	3430	10.6	10.1	9.7
	25 + 35 + 35	2.37	3.32	3.32	—	3.2	9.0	9.1	660	2300	3430	10.6	10.1	9.7
	25 + 35 + 50	2.05	2.86	4.09	—	3.2	9.0	9.1	660	2300	3430	10.6	10.1	9.7
	25 + 35 + 60	1.88	2.63	4.50	—	3.2	9.0	9.1	660	2300	3430	10.6	10.1	9.7
	25 + 50 + 50	1.80	3.60	3.60	—	3.2	9.0	9.1	660	2300	3430	10.6	10.1	9.7
	25 + 50 + 60	1.67	3.33	4.00	—	3.2	9.0	9.1	660	2300	3430	10.6	10.1	9.7
35 + 35 + 35	3.00	3.00	3.00	—	3.2	9.0	9.1	660	2300	3430	10.6	10.1	9.7	
35 + 35 + 50	2.63	2.63	3.75	—	3.2	9.0	9.1	660	2300	3430	10.6	10.1	9.7	
35 + 35 + 60	2.42	2.42	4.15	—	3.2	9.0	9.1	660	2300	3430	10.6	10.1	9.7	
35 + 50 + 50	2.33	3.33	3.33	—	3.2	9.0	9.1	660	2300	3430	10.6	10.1	9.7	
4 room	20 + 20 + 20 + 20	2.28	2.28	2.28	2.28	3.6	9.1	9.5	800	2270	3430	10.4	10.0	9.6
	20 + 20 + 20 + 25	2.14	2.14	2.14	2.68	3.6	9.1	9.5	800	2270	3430	10.4	10.0	9.6
	20 + 20 + 20 + 35	1.94	1.94	1.94	3.39	3.6	9.2	9.5	800	2290	3430	10.5	10.1	9.6
	20 + 20 + 20 + 50	1.67	1.67	1.67	4.18	3.6	9.2	9.5	800	2290	3430	10.5	10.1	9.6
	20 + 20 + 20 + 60	1.55	1.55	1.55	4.65	3.6	9.3	9.5	800	2310	3430	10.7	10.2	9.8
	20 + 20 + 25 + 25	2.04	2.04	2.56	2.56	3.6	9.2	9.5	800	2290	3430	10.5	10.1	9.6
	20 + 20 + 25 + 35	1.84	1.84	2.30	3.22	3.6	9.2	9.5	800	2290	3430	10.5	10.1	9.6
	20 + 20 + 25 + 50	1.62	1.62	2.02	4.04	3.6	9.3	9.5	800	2310	3430	10.7	10.2	9.8
	20 + 20 + 25 + 60	1.49	1.49	1.86	4.46	3.6	9.3	9.5	800	2310	3430	10.7	10.2	9.8
	20 + 20 + 35 + 35	1.67	1.67	2.93	2.93	3.6	9.2	9.5	800	2290	3430	10.5	10.1	9.6
	20 + 20 + 35 + 50	1.49	1.49	2.60	3.72	3.6	9.3	9.5	800	2310	3430	10.7	10.2	9.8
	20 + 20 + 35 + 60	1.38	1.38	2.41	4.13	3.6	9.3	9.5	800	2310	3430	10.7	10.2	9.8
	20 + 25 + 25 + 25	1.94	2.42	2.42	2.42	3.6	9.2	9.5	800	2290	3430	10.5	10.1	9.6
	20 + 25 + 25 + 35	1.75	2.19	2.19	3.07	3.6	9.2	9.5	800	2290	3430	10.5	10.1	9.6
	20 + 25 + 25 + 50	1.55	1.94	1.94	3.88	3.6	9.3	9.5	800	2310	3430	10.7	10.2	9.8
	20 + 25 + 25 + 60	1.43	1.79	1.79	4.29	3.6	9.3	9.5	800	2310	3430	10.7	10.2	9.8
	20 + 25 + 35 + 35	1.62	2.02	2.83	2.83	3.6	9.3	9.5	800	2310	3430	10.7	10.2	9.8
	20 + 25 + 35 + 50	1.43	1.79	2.50	3.58	3.6	9.3	9.5	800	2310	3430	10.7	10.2	9.8
	20 + 35 + 35 + 35	1.49	2.60	2.60	2.60	3.6	9.3	9.5	800	2310	3430	10.7	10.2	9.8
	25 + 25 + 25 + 25	2.30	2.30	2.30	2.30	3.6	9.2	9.5	800	2290	3430	10.5	10.1	9.6
	25 + 25 + 25 + 35	2.09	2.09	2.09	2.93	3.6	9.2	9.5	800	2290	3430	10.5	10.1	9.6
	25 + 25 + 25 + 50	1.86	1.86	1.86	3.72	3.6	9.3	9.5	800	2310	3430	10.7	10.2	9.8
	25 + 25 + 25 + 60	1.72	1.72	1.72	4.13	3.6	9.3	9.5	800	2310	3430	10.7	10.2	9.8
25 + 25 + 35 + 35	1.94	1.94	2.71	2.71	3.6	9.3	9.5	800	2310	3430	10.7	10.2	9.8	
25 + 25 + 35 + 50	1.72	1.72	2.41	3.44	3.6	9.3	9.5	800	2310	3430	10.7	10.2	9.8	
25 + 35 + 35 + 35	1.79	2.50	2.50	2.50	3.6	9.3	9.5	800	2310	3430	10.7	10.2	9.8	

**Table of Indoor unit combination SCM80ZJ-S**  
**<with indoor unit except all indoor unit SRK-ZJX-S type only>**  
**(Cooling operation)**

Indoor unit combination	Cooling capacity (kW)							Power consumption (W)			Standard current (A)			
	Room cooling capacity (kW)				Total capacity (kW)			Min.	Standard	Max.	220V	230V	240V	
	A room	B room	C room	D room	Min.	Standard	Max.							
1 room	20	2.0	—	—	—	1.8	2.0	2.7	480	530	950	2.4	2.3	2.2
	25	2.5	—	—	—	1.8	2.5	3.2	480	730	1080	3.4	3.2	3.1
	35	3.5	—	—	—	1.8	3.5	3.7	480	1120	1240	5.1	4.9	4.7
	50	5.0	—	—	—	1.8	5.0	5.8	480	1710	2100	7.9	7.5	7.2
	60	6.0	—	—	—	1.8	6.0	6.7	480	2140	2700	9.8	9.4	9.0
2 room	20 + 20	2.00	2.00	—	—	3.0	4.0	5.8	550	930	1910	4.3	4.1	3.9
	20 + 25	2.00	2.50	—	—	3.0	4.5	6.1	550	1170	2060	5.4	5.1	4.9
	20 + 35	2.00	3.50	—	—	3.0	5.5	6.6	550	1590	2320	7.3	7.0	6.7
	20 + 50	1.97	4.93	—	—	3.0	6.9	7.5	550	2200	2830	10.1	9.7	9.3
	20 + 60	1.85	5.55	—	—	3.0	7.4	7.5	550	2430	2830	11.2	10.7	10.2
	25 + 25	2.50	2.50	—	—	3.0	5.0	6.5	550	1360	2270	6.2	6.0	5.7
	25 + 35	2.46	3.44	—	—	3.0	5.9	6.8	550	1780	2470	8.2	7.8	7.5
	25 + 50	2.47	4.93	—	—	3.0	7.4	7.5	550	2430	2830	11.2	10.7	10.2
	25 + 60	2.18	5.22	—	—	3.0	7.4	7.5	550	2430	2830	11.2	10.7	10.2
	35 + 35	3.45	3.45	—	—	3.0	6.9	7.5	550	2200	2680	10.1	9.7	9.3
	35 + 50	3.05	4.35	—	—	3.0	7.4	7.5	550	2430	2830	11.2	10.7	10.2
	35 + 60	2.73	4.67	—	—	3.0	7.4	7.5	550	2430	2830	11.2	10.7	10.2
	50 + 50	3.70	3.70	—	—	3.0	7.4	7.5	550	2430	2830	11.2	10.7	10.2
	50 + 60	3.36	4.04	—	—	3.0	7.4	7.5	550	2430	2830	11.2	10.7	10.2
60 + 60	3.70	3.70	—	—	3.0	7.4	7.5	550	2430	2830	11.2	10.7	10.2	
3 room	20 + 20 + 20	2.00	2.00	2.00	—	3.7	6.0	8.1	670	1450	2830	6.7	6.4	6.1
	20 + 20 + 25	2.00	2.00	2.50	—	3.7	6.5	8.1	670	1630	2830	7.5	7.2	6.9
	20 + 20 + 35	1.89	1.89	3.31	—	3.7	7.1	8.1	670	1950	2830	9.0	8.6	8.2
	20 + 20 + 50	1.73	1.73	4.33	—	3.7	7.8	8.1	670	2320	2830	10.7	10.2	9.8
	20 + 20 + 60	1.56	1.56	4.68	—	3.7	7.8	8.1	670	2320	2830	10.7	10.2	9.8
	20 + 25 + 25	1.94	2.43	2.43	—	3.7	6.8	8.1	670	1820	2830	8.4	8.0	7.7
	20 + 25 + 35	1.88	2.34	3.28	—	3.7	7.5	8.1	670	2130	2830	9.8	9.4	9.0
	20 + 25 + 50	1.64	2.05	4.11	—	3.7	7.8	8.1	670	2320	2830	10.7	10.2	9.8
	20 + 25 + 60	1.49	1.86	4.46	—	3.7	7.8	8.1	670	2320	2830	10.7	10.2	9.8
	20 + 35 + 35	1.73	3.03	3.03	—	3.7	7.8	8.1	670	2320	2830	10.7	10.2	9.8
	20 + 35 + 50	1.49	2.60	3.71	—	3.7	7.8	8.1	670	2320	2830	10.7	10.2	9.8
	20 + 35 + 60	1.36	2.37	4.07	—	3.7	7.8	8.1	670	2320	2830	10.7	10.2	9.8
	20 + 50 + 50	1.30	3.25	3.25	—	3.7	7.8	8.1	670	2320	2830	10.7	10.2	9.8
	20 + 50 + 60	1.20	3.00	3.60	—	3.7	7.8	8.1	670	2320	2830	10.7	10.2	9.8
	25 + 25 + 25	2.37	2.37	2.37	—	3.7	7.1	8.1	670	1950	2830	9.0	8.6	8.2
	25 + 25 + 35	2.29	2.29	3.21	—	3.7	7.8	8.1	670	2320	2830	10.7	10.2	9.8
	25 + 25 + 50	1.95	1.95	3.90	—	3.7	7.8	8.1	670	2320	2830	10.7	10.2	9.8
	25 + 25 + 60	1.77	1.77	4.25	—	3.7	7.8	8.1	670	2320	2830	10.7	10.2	9.8
	25 + 35 + 35	2.05	2.87	2.87	—	3.7	7.8	8.1	670	2320	2830	10.7	10.2	9.8
	25 + 35 + 50	1.77	2.48	3.55	—	3.7	7.8	8.1	670	2320	2830	10.7	10.2	9.8
	25 + 35 + 60	1.63	2.28	3.90	—	3.7	7.8	8.1	670	2320	2830	10.7	10.2	9.8
	25 + 50 + 50	1.56	3.12	3.12	—	3.7	7.8	8.1	670	2320	2830	10.7	10.2	9.8
	25 + 50 + 60	1.44	2.89	3.47	—	3.7	7.8	8.1	670	2320	2830	10.7	10.2	9.8
	35 + 35 + 35	2.60	2.60	2.60	—	3.7	7.8	8.1	670	2320	2830	10.7	10.2	9.8
35 + 35 + 50	2.28	2.28	3.25	—	3.7	7.8	8.1	670	2320	2830	10.7	10.2	9.8	
35 + 35 + 60	2.10	2.10	3.60	—	3.7	7.8	8.1	670	2320	2830	10.7	10.2	9.8	
35 + 50 + 50	2.02	2.89	2.89	—	3.7	7.8	8.1	670	2320	2830	10.7	10.2	9.8	
4 room	20 + 20 + 20 + 20	1.95	1.95	1.95	1.95	4.4	7.8	8.7	890	2180	2830	9.9	9.5	9.1
	20 + 20 + 20 + 25	1.84	1.84	1.84	2.29	4.4	7.8	8.7	890	2180	2830	9.9	9.5	9.1
	20 + 20 + 20 + 35	1.66	1.66	1.66	2.91	4.4	7.9	8.7	890	2200	2830	10.0	9.6	9.2
	20 + 20 + 20 + 50	1.44	1.44	1.44	3.59	4.4	7.9	8.7	890	2200	2830	10.0	9.6	9.2
	20 + 20 + 20 + 60	1.33	1.33	1.33	4.00	4.4	8.0	8.7	890	2220	2830	10.1	9.7	9.3
	20 + 20 + 25 + 25	1.76	1.76	2.19	2.19	4.4	7.9	8.7	890	2200	2830	10.0	9.6	9.2
	20 + 20 + 25 + 35	1.58	1.58	1.98	2.77	4.4	7.9	8.7	890	2200	2830	10.0	9.6	9.2
	20 + 20 + 25 + 50	1.37	1.37	1.72	3.43	4.4	7.9	8.7	890	2200	2830	10.0	9.6	9.2
	20 + 20 + 25 + 60	1.28	1.28	1.60	3.84	4.4	8.0	8.7	890	2220	2830	10.1	9.7	9.3
	20 + 20 + 35 + 35	1.44	1.44	2.51	2.51	4.4	7.9	8.7	890	2200	2830	10.0	9.6	9.2
	20 + 20 + 35 + 50	1.28	1.28	2.24	3.20	4.4	8.0	8.7	890	2220	2830	10.1	9.7	9.3
	20 + 20 + 35 + 60	1.19	1.19	2.07	3.56	4.4	8.0	8.7	890	2220	2830	10.1	9.7	9.3
	20 + 25 + 25 + 25	1.66	2.08	2.08	2.08	4.4	7.9	8.7	890	2200	2830	10.0	9.6	9.2
	20 + 25 + 25 + 35	1.50	1.88	1.88	2.63	4.4	7.9	8.7	890	2200	2830	10.0	9.6	9.2
	20 + 25 + 25 + 50	1.33	1.67	1.67	3.33	4.4	8.0	8.7	890	2220	2830	10.1	9.7	9.3
	20 + 25 + 25 + 60	1.23	1.54	1.54	3.69	4.4	8.0	8.7	890	2220	2830	10.1	9.7	9.3
	20 + 25 + 35 + 35	1.37	1.72	2.40	2.40	4.4	7.9	8.7	890	2200	2830	10.0	9.6	9.2
	20 + 25 + 35 + 50	1.23	1.54	2.15	3.08	4.4	8.0	8.7	890	2220	2830	10.1	9.7	9.3
	20 + 35 + 35 + 35	1.28	2.24	2.24	2.24	4.4	8.0	8.7	890	2220	2830	10.1	9.7	9.3
	25 + 25 + 25 + 25	1.98	1.98	1.98	1.98	4.4	7.9	8.7	890	2200	2830	10.0	9.6	9.2
	25 + 25 + 25 + 35	1.80	1.80	1.80	2.51	4.4	7.9	8.7	890	2200	2830	10.0	9.6	9.2
	25 + 25 + 25 + 50	1.60	1.60	1.60	3.20	4.4	8.0	8.7	890	2220	2830	10.1	9.7	9.3
	25 + 25 + 25 + 60	1.48	1.48	1.48	3.56	4.4	8.0	8.7	890	2220	2830	10.1	9.7	9.3
	25 + 25 + 35 + 35	1.67	1.67	2.33	2.33	4.4	8.0	8.7	890	2220	2830	10.1	9.7	9.3
25 + 25 + 35 + 50	1.48	1.48	2.07	2.96	4.4	8.0	8.7	890	2220	2830	10.1	9.7	9.3	
25 + 35 + 35 + 35	1.54	2.15	2.15	2.15	4.4	8.0	8.7	890	2220	2830	10.1	9.7	9.3	

# Control option

## Wired remote control can be connected

Model	Interface	Remote Control
SRK63/71ZE-S1 SRK63/71HE-S1	not required	RC-E1R
SRK20~60ZJX-S SRK25/35ZJR-S SRK20~50ZJ-S SRF25/35/50ZJX-S SRR25/35ZJ-S	SC-BIKN-E	RC-E4
FDTC25~60VD ※	not required	

※ If wireless remote control is required, use RCN-TC-24W-ER

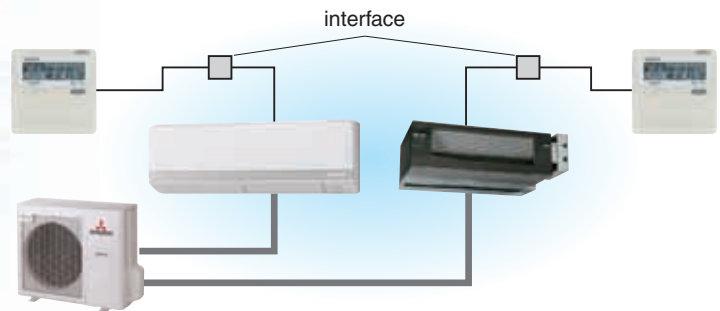

## Can be connected to SUPERLINK-II

Model	Interface	Remote Control
SRK20~60ZJX-S SRK25/35ZJR-S SRK20~50ZJ-S SRF25/35/50ZJX-S SRR25/35ZJ-S	SC-BIKN-E SC-ADNA-E	RC-E4
FDTC25~60VD	SC-ADNA-E	

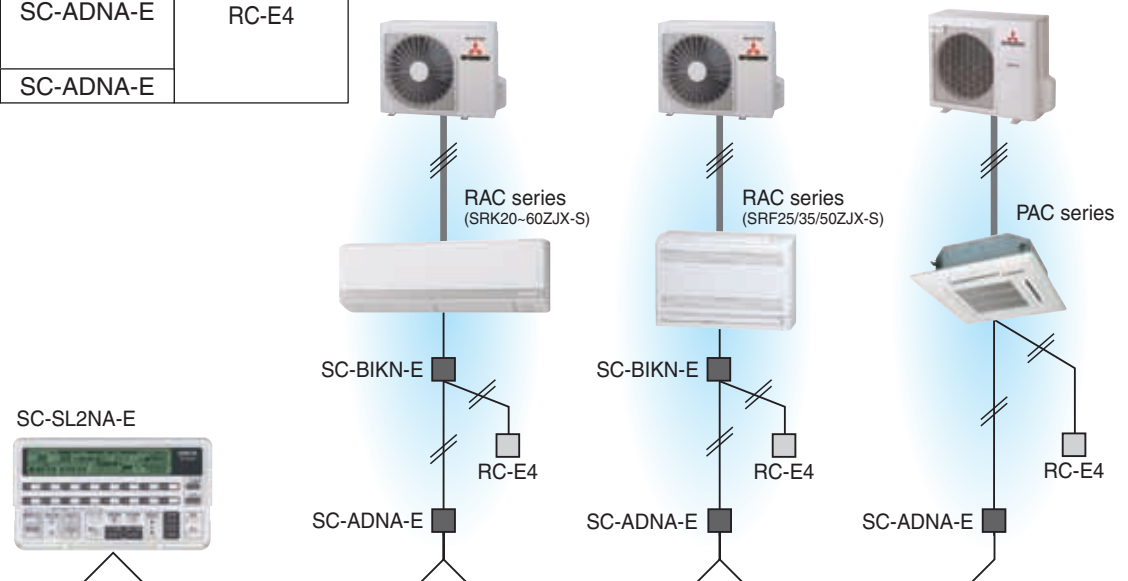

## CnT terminal is equipped

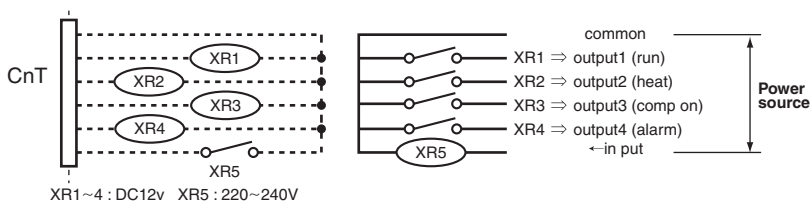

Model	Interface
SRK63/71ZE-S1 SRK63/71HE-S1 FDTC25~60VD	not required
SRK20~60ZJX-S SRK25/35ZJR-S SRK20~50ZJ-S SRF25/35/50ZJX-S SRR25/35ZJ-S	SC-BIKN-E



Remote surveillance system



Card key on-off

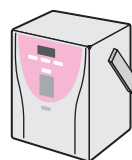

Humidifier linkage

## INDOOR UNIT

Unit: mm

### Wall mounted type

**SRK20ZJX-S SRK25ZJX-S SRK35ZJX-S  
SRK50ZJX-S SRK60ZJX-S**

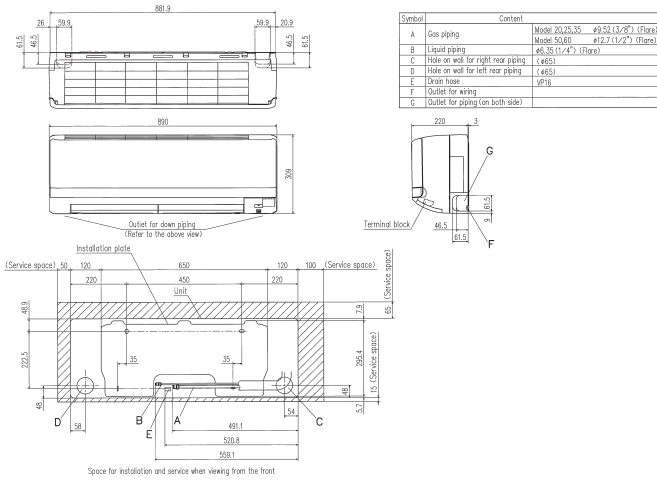

**SRK25ZJR-S SRK35ZJR-S  
SRK20ZJ-S SRK25ZJ-S SRK35ZJ-S SRK50ZJ-S**

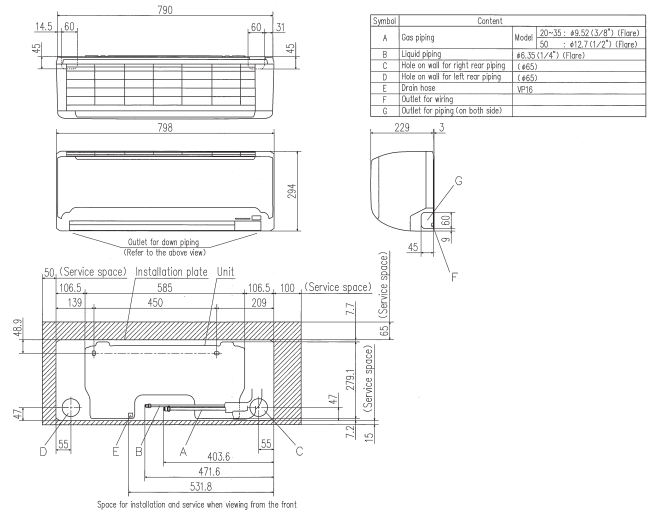

**SRK25ZJP-S SRK35ZJP-S SRK50ZJP-S**

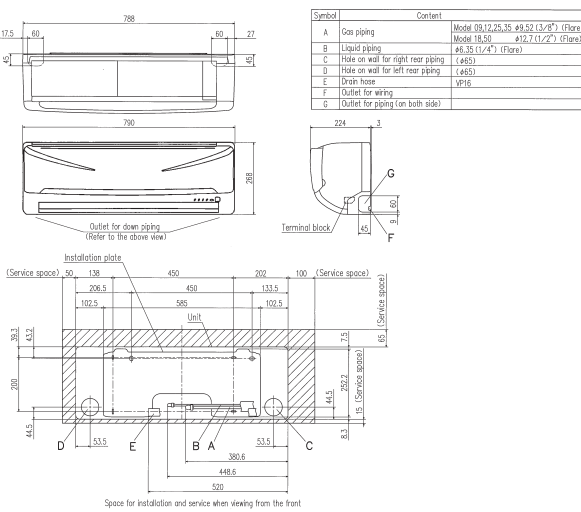

**SRK63ZE-S1 SRK71ZE-S1 SRK63HE-S1 SRK71HE-S1**

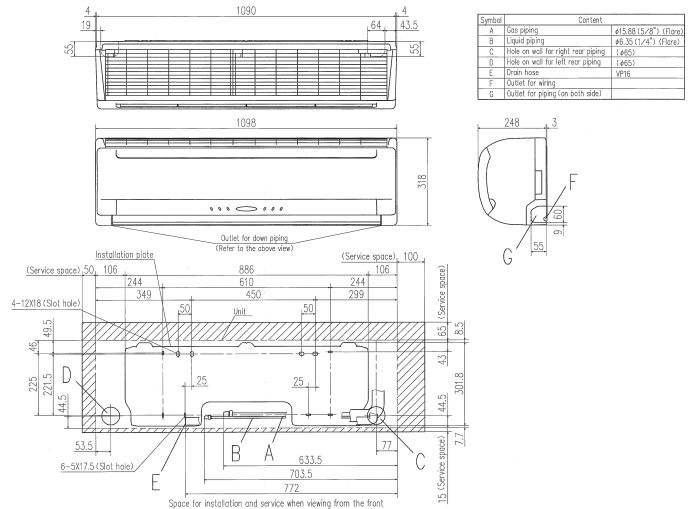

**SRK20HG-S SRK28HG-S SRK40HG-S**

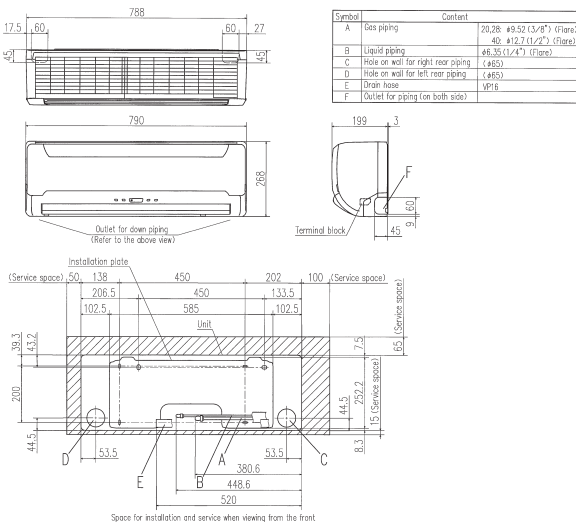

**SRK50HE-S1 SRK56HE-S1**

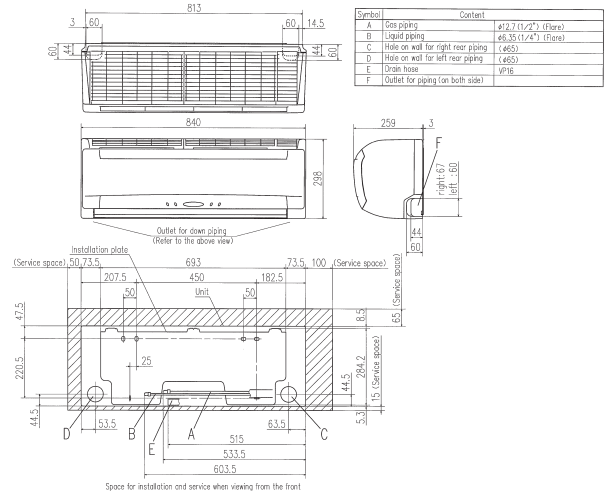

## INDOOR UNIT

Unit: mm

### Floor standing type

SRF25ZJX-S SRF35ZJX-S SRF50ZJX-S

Symbol	Content
A	Gas piping Model 25.35 : $\phi 9.52$ (3/8") (Flare) 30 : $\phi 12.7$ (1/2") (Flare)
B	Liquid piping $\phi 6.35$ (1/4") (Flare)
C	Hole on wall for right rear piping ( $\phi 6.35$ )
D	Hole on wall for left rear piping ( $\phi 6.35$ )
E	Drain hose VP16
F	Screw point, fasten the indoor unit $\phi 5$
G	Outlet for piping (on both side)

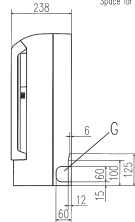
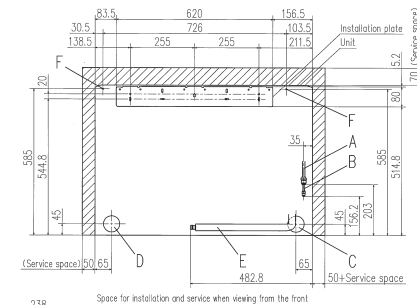
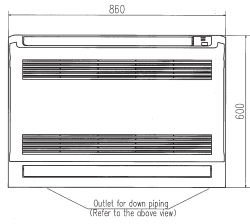
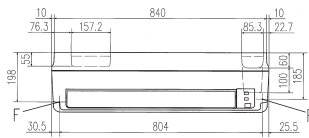

### Ceiling Concealed

SRR25ZJ-S SRR35ZJ-S SRR50ZJ-S SRR60ZJ-S

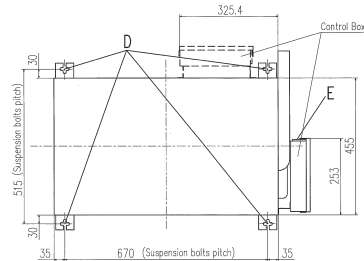

Symbol	Content
Model	SRR25ZJ-S, S3ZJ-S / SRR50ZJ-S, 60ZJ-S
A	Gas piping $\phi 9.52$ (3/8") (Flare) / $\phi 12.7$ (1/2") (Flare)
B	Liquid piping $\phi 6.35$ (1/4") (Flare)
C	Drain piping VP16
D	Suspension bolts (M8)
E	Power supply intake ( $\phi 3.5$ )

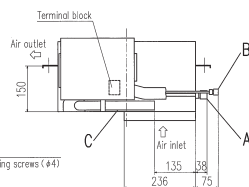
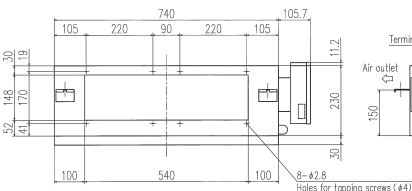

### 4way ceiling cassette type

FDTC25VD FDTC35VD FDTC40VD FDTC50VD FDTC60VD

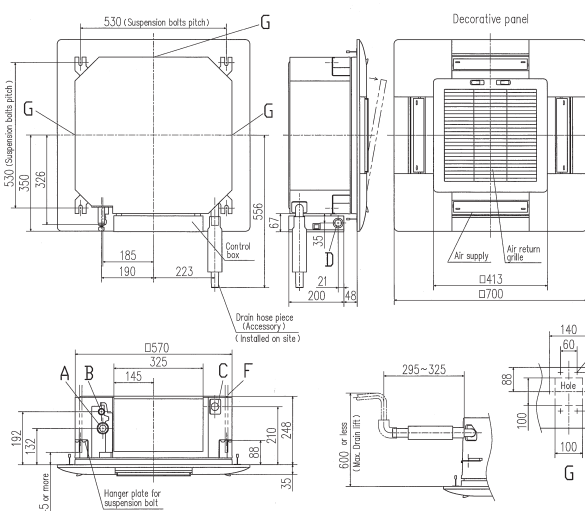

Symbol	Content
A	Gas piping Model 25.35 : $\phi 9.52$ (3/8") (Flare) 40-50 : $\phi 12.7$ (1/2") (Flare)
B	Liquid piping $\phi 6.35$ (1/4") (Flare)
C	Drain piping VP20 (I.D. 20.0, O.D. 26) Note (2)
D	Hole for wiring $\phi 25$
F	Suspension bolts (M10 or M8)
G	Air outlet opening for ducting (Knock out)

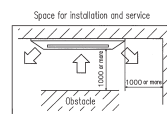

# OUTDOOR UNIT

Unit: mm

## SRC20ZJX-S SRC25ZJX-S SRC35ZJX-S SRC25ZJR-S SRC35ZJR-S

Symbol	Content
A	Service valve connection (gas side) $\phi 9.52$ (3/8") (Flare)
B	Service valve connection (liquid side) $\phi 6.35$ (1/4") (Flare)
C	Pipe/cable draw-out hole
D	Drain discharge hole $\phi 20 \times 2$ places
E	Anchor bolt hole M10 $\times 4$ places

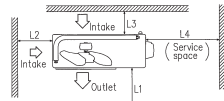

Minimum installation space

Examples of application Dimensions	I	II	III	IV
L1	Open	280	280	180
L2	100	75	Open	Open
L3	100	80	80	80
L4	250	Open	250	Open

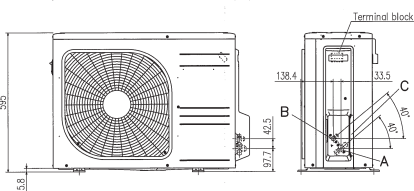
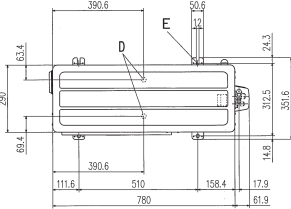

## SRC40ZIX-S SRC50ZIX-S SRC60ZIX-S SRC50ZJ-S SRC50ZJP-S

Symbol	Content
A	Service valve connection (gas side) $\phi 12.7$ (1/2") (Flare)
B	Service valve connection (liquid side) $\phi 6.35$ (1/4") (Flare)
C	Pipe/cable draw-out hole
D	Drain discharge hole $\phi 20 \times 5$ places
E	Anchor bolt hole M10 $\times 4$ places

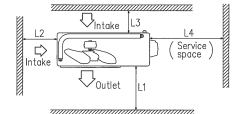

Minimum installation space

Examples of application Dimensions	I	II	III	IV
L1	Open	280	280	180
L2	100	75	Open	Open
L3	100	80	80	80
L4	250	Open	250	Open

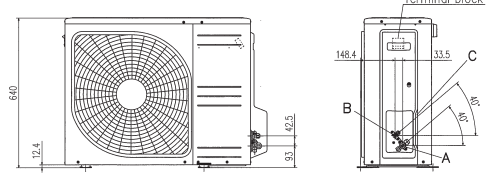
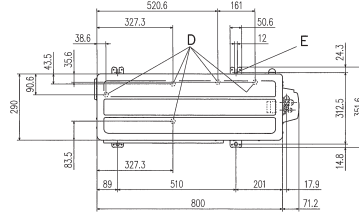

## SRC20ZJ-S SRC25ZJ-S SRC35ZJ-S SRC25ZJP-S SRC35ZJP-S

Symbol	Content
A	Service valve connection (gas side) $\phi 9.52$ (3/8") (Flare)
B	Service valve connection (liquid side) $\phi 6.35$ (1/4") (Flare)
C	Pipe/cable draw-out hole
D	Drain discharge hole $\phi 20 \times 2$ places
E	Anchor bolt hole M10 $\times 4$ places

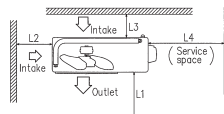

Minimum installation space

Examples of application Dimensions	I	II	III	IV
L1	Open	280	280	180
L2	100	75	Open	Open
L3	100	80	80	80
L4	250	Open	250	Open

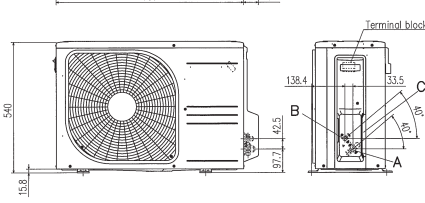
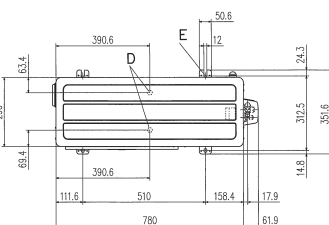

## SRC20HG-S SRC28HG-S SRC40HG-S

Symbol	Content
A	Service valve connection (gas side) $\phi 20.26$ (3/8") (Flare)
B	Service valve connection (liquid side) $\phi 9.52$ (3/8") (Flare)
C	Pipe/cable draw-out hole
D	Drain discharge hole $\phi 20 \times 3$ places
E	Anchor bolt hole M10 $\times 4$ places

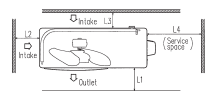

Minimum installation space

Examples of application Dimensions	I	II	III	IV
L1	600			
L2	100			
L3	100			
L4	OPEN			

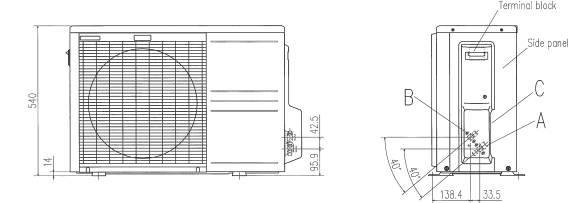
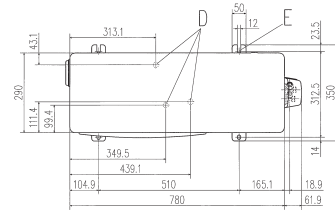

## SRC50HE-S1 SRC56HE-S1 SRC63HE-S1

Symbol	Content
A	Service valve connection (gas side) $\phi 12.7$ (1/2") (Flare)
B	Service valve connection (liquid side) $\phi 6.35$ (1/4") (Flare)
C	Pipe/cable draw-out hole
D	Drain discharge hole $\phi 20 \times 3$ places
E	Anchor bolt hole M10 $\times 4$ places

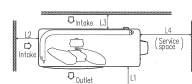

Minimum installation space

Examples of application Dimensions	I	II	III	IV
L1	600			
L2	100			
L3	100			
L4	OPEN			

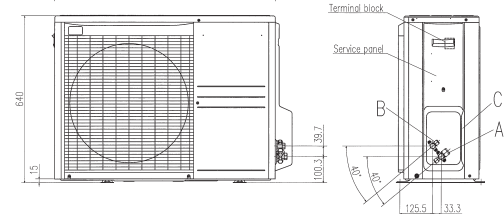
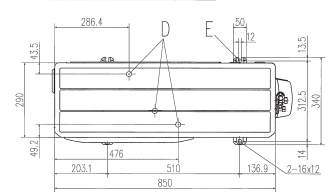

## SRC63ZE-S1 SRC71ZE-S1 SRC71HE-S1

Symbol	Content
A	Service valve connection (gas side) $\phi 15.88$ (5/8") (Flare)
B	Service valve connection (liquid side) $\phi 6.35$ (1/4") (Flare)
C	Pipe/cable draw-out hole
D	Drain discharge hole $\phi 20 \times 3$ places
E	Anchor bolt hole M10 $\times 4$ places

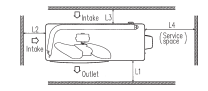

Minimum installation space

Examples of application Dimensions	I	II	III	IV
L1	600			
L2	100			
L3	100			
L4	OPEN			

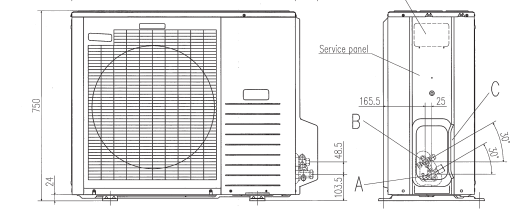
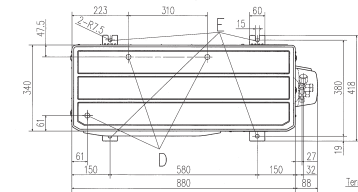

## OUTDOOR UNIT

Unit: mm

### SCM40ZJ-S SCM45ZJ-S

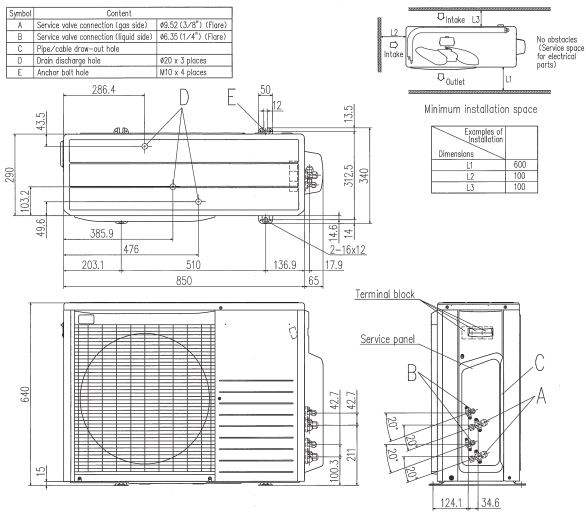

### SCM50ZJ-S SCM60ZJ-S

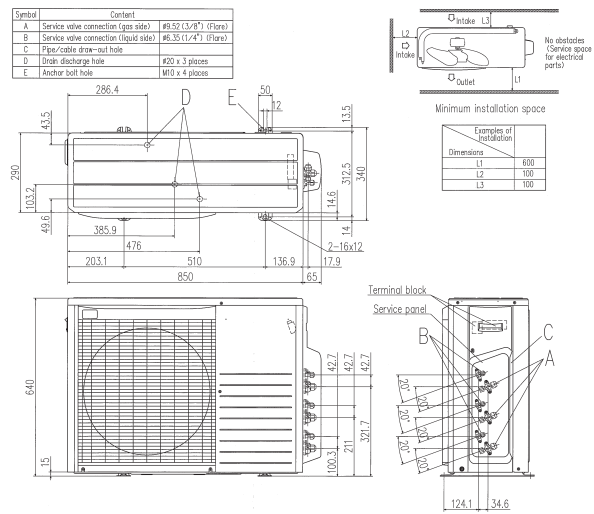

### SCM71ZJ-S SCM80ZJ-S

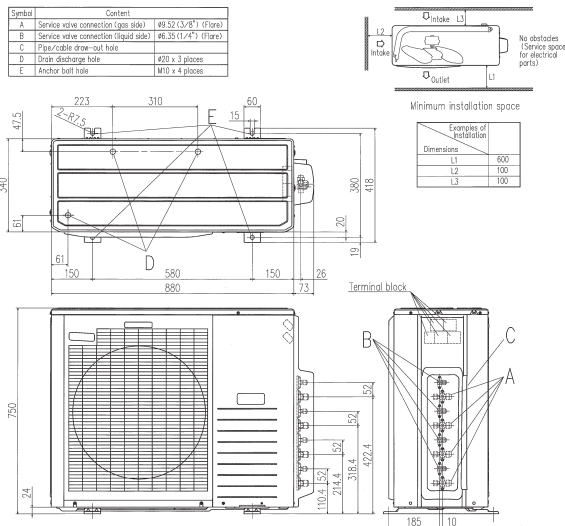

# MEMO

---

## Before starting use

### Heating performance

The heating performance values (kW) described in catalog are the values obtained by operating at an outdoor temperature of 7°C and indoor temperature of 20°C as set forth in the ISO Standards. As the heating performance decreases as the outdoor temperature drops, if the outdoor temperature is too low and the heating performance is insufficient, use other heating appliances as well.

### Indication of sound values

The sound values are the values (A scale) measured in a chamber such as an anechoic chamber following the ISO Standards. In the actual installation state, the value is normally larger than the values given in the catalog due to the effect of surrounding noise and echo. Take this into consideration when installing.

### Use in oil atmosphere

Avoid installing this unit in an atmosphere where oil scatters or builds up, such as in a kitchen or machine factory. If the oil adheres to the heat exchanger, the heat exchanging performance will drop, mist may be generated, and the synthetic resin parts may deform and break.

### Use in acidic or alkaline atmosphere

If this unit is used in acidic atmosphere such as hot spring areas having high level of sulfuric gases or in alkaline atmosphere including ammonia or calcium chloride, places where the exhaust of the heat exchanger is sucked in, or at coastal areas where the unit is subject to salt breezes, the outer plate or heat exchanger, etc., will corrode. Please ask a dealer or specialist when you use an air conditioner in places differing from a general atmosphere.

### Use in places with high ceilings

If the ceiling is high, install a circulator to improve the heat and air flow distribution when heating.

### Refrigerant leakage

The refrigerant (R410A) used for the Residential Air conditioner is non-toxic and inflammable in its original state. However, in consideration of a state where the refrigerant leaks into the room, measures against refrigerant leaks must be taken in small rooms where the tolerable level could be exceeded. Take measures by installing ventilation devices, etc.

### Use in snowy areas

Take the following measures when installing the outdoor unit in snowy areas.

#### •Snow-prevention

Install a snow-prevention hood so that the snow does not obstruct the air intake port or enter and freeze in the outdoor unit.

#### •Snow piling

In areas with heavy snow fall, the piled snow could block the air intake port. In this case, a frame that is 50cm or higher than the estimated snow fall must be installed underneath the outdoor unit.

### Automatic defrosting device

If the temperature is low, and the humidity is high, frost will stick to the heat exchanger of the outdoor unit. If use is continued, the heating performance will drop.

The "Automatic defrosting device" will function to remove this frost. After heating for approx. three to ten minutes, it will stop, and the frost will be removed. After defrosting, hot air will be blown again.

### Servicing the air-conditioner

After the air-conditioner is used for several seasons, dirt will build up in the air-conditioner causing the performance to drop. In addition to regular servicing, we recommend the maintenance contract (charged for) by a specialist.

## ⚠ Safety Precautions

### Air-conditioner usage target

The air-conditioner described in this catalog is a dedicated cooling/heating device for human use.

Do not use it for special applications such as the storage of foodstuffs, animals or plants, precision devices or valuable art, etc.

This could cause the quality of the items to drop, etc.

Do not use this for cooling vehicles or ships. Water leakage or current leaks could occur.

### Before use

Always read the "User's Manual" thoroughly before starting use.

### Installation

Always commission the installation to a dealer or specialist. Improper installation will lead to water leakage, electric shocks and fires.

Make sure that the outdoor unit is stable in installation. Fix the unit to stable base.

### Usage place

Do not install in places where combustible gas could leak or where there are sparks.

Installation in a place where combustible gas could be generated, flow or accumulate, or places containing carbon fibers could lead to fires.



**Japan Head Office:**  
Mitsubishi Heavy Industries Ltd  
16-5 2-Chome Kounan Minato-ku Tokyo  
108-8215, Japan  
[www.mhi.co.jp](http://www.mhi.co.jp)

Our factories are ISO9001 and ISO14001 certified.

Certified ISO 9001



BIWAJIMA PLANT  
Mitsubishi Heavy Industries, Ltd.  
Air-conditioning & Refrigeration Systems Headquarters  
Certified ISO 9001  
Certificate number: JQA-0709



MITSUBISHI HEAVY INDUSTRIES-  
MAHAJAK AIR CONDITIONERS CO., LTD.  
Certified ISO 9001  
Certificate Number: 04104 1998 0813

Certified ISO 14001



BIWAJIMA PLANT  
Mitsubishi Heavy Industries, Ltd.  
Air-conditioning & Refrigeration Systems Headquarters  
Certified ISO 14001  
Certificate number: JQA-EM256



MITSUBISHI HEAVY INDUSTRIES-  
MAHAJAK AIR CONDITIONERS CO., LTD.  
Certified ISO 14001  
Certificate Number: 04104 1998 0813 ES



3D Air Sales Limited  
01753 495720

HRP Limited  
01359 270888